

A5. Abigail

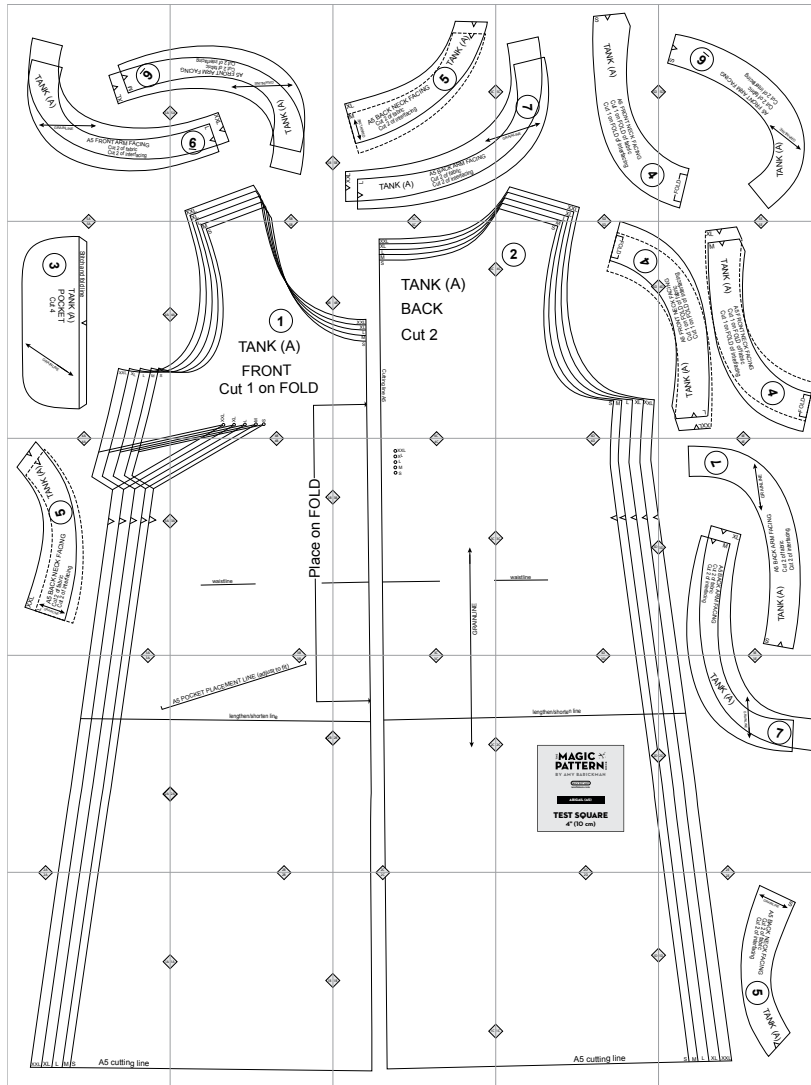

Copyright ©2014 by Amy Barickman

All rights reserved. Amy Barickman's patterns may be printed for personal use, but may not be otherwise reproduced—mechanically, electronically, or by any other means, including photocopying—without written permission of the publisher.

Sewing pattern designs for *The Magic Pattern Book* by Amy Barickman are intended for personal use only, and not as the basis for commercial manufacturing.

Workman Publishing, New York • workman.com

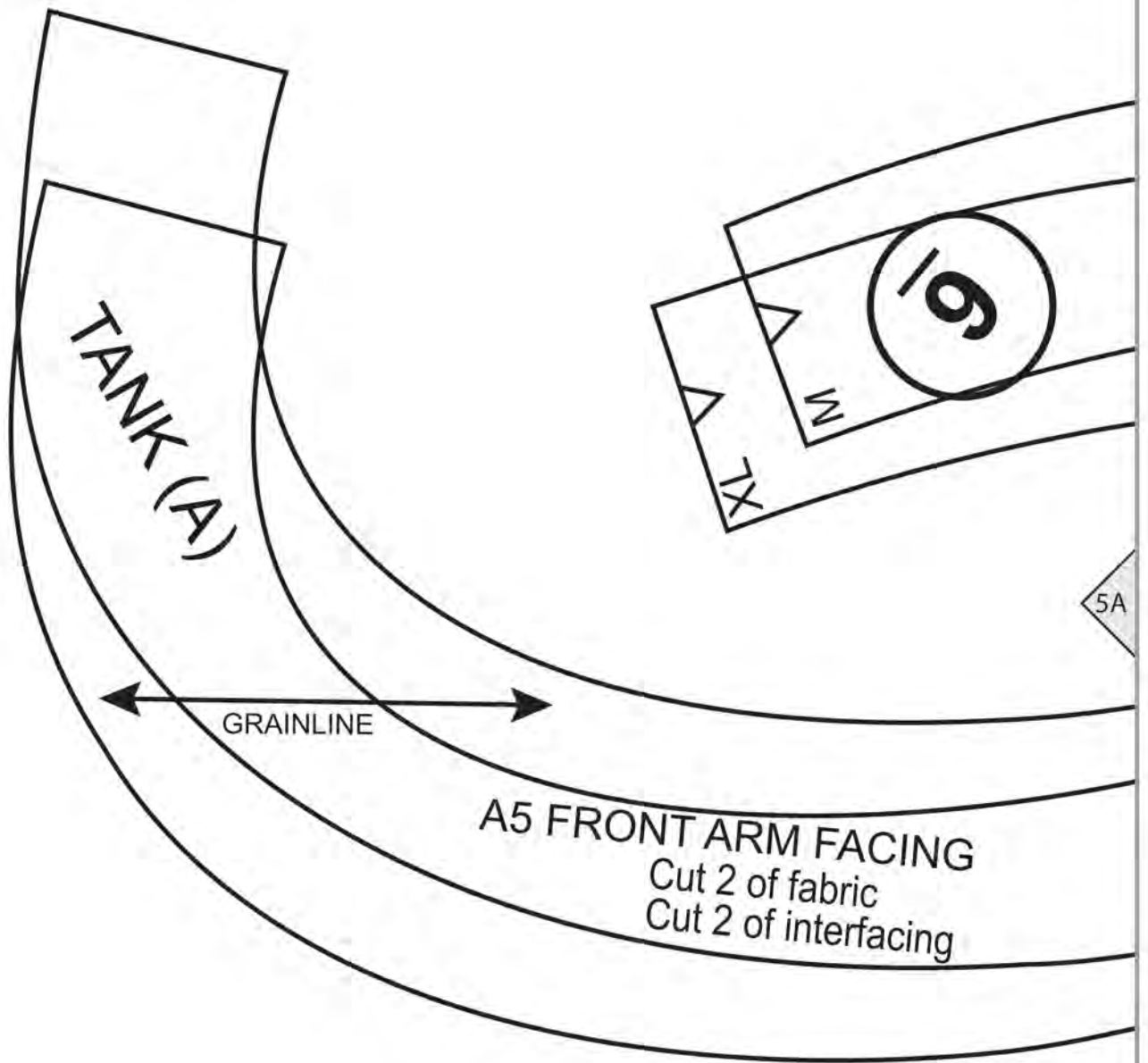

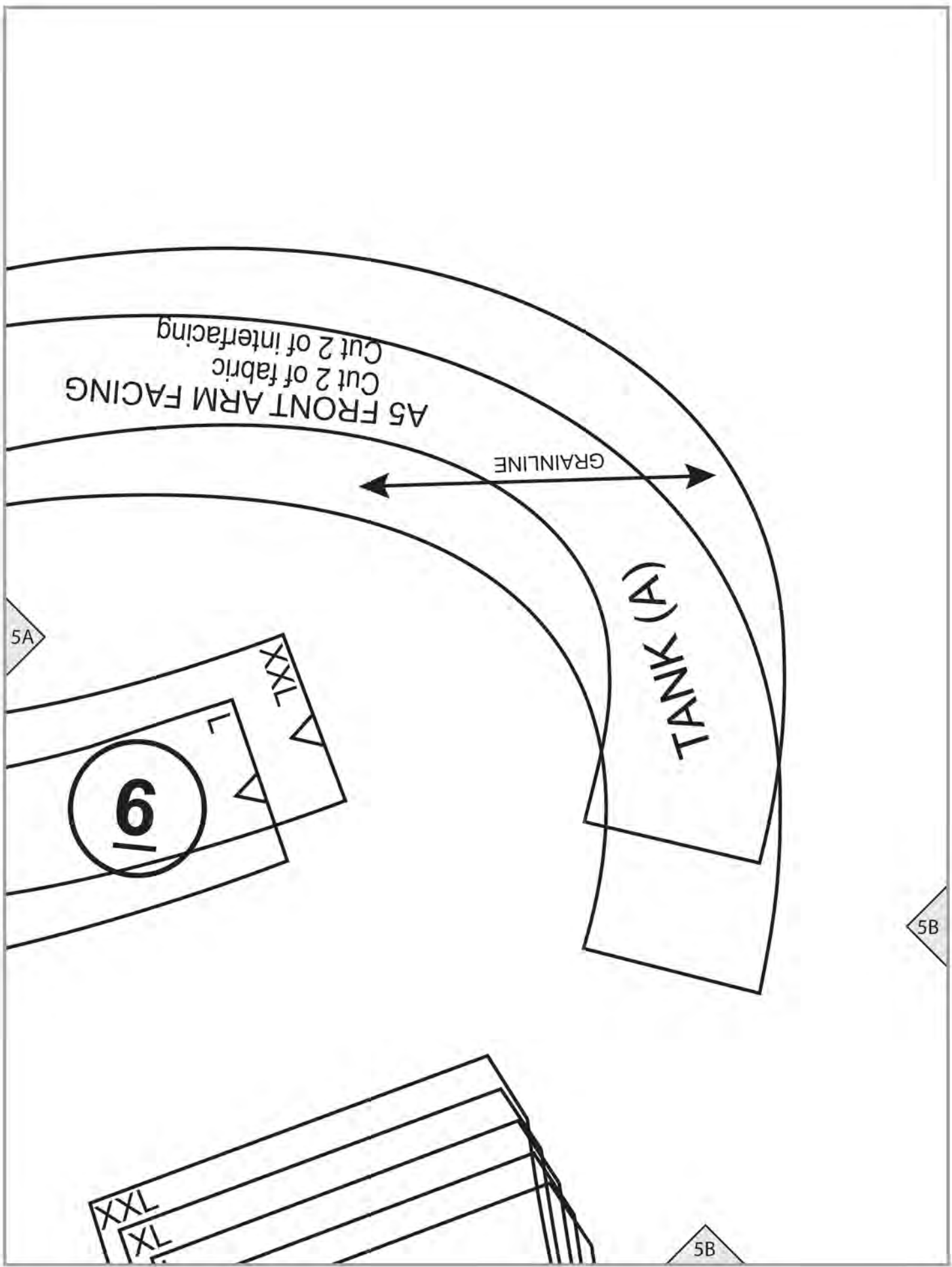

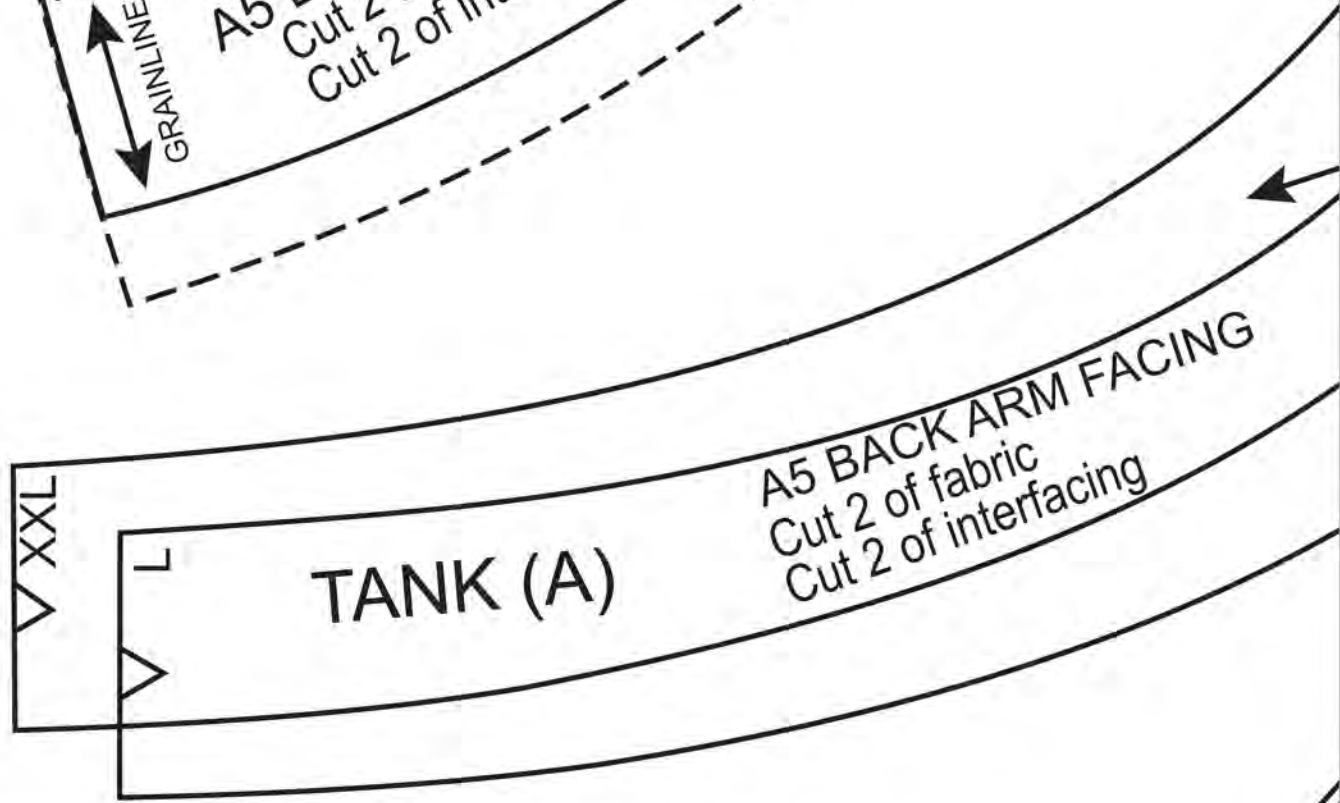
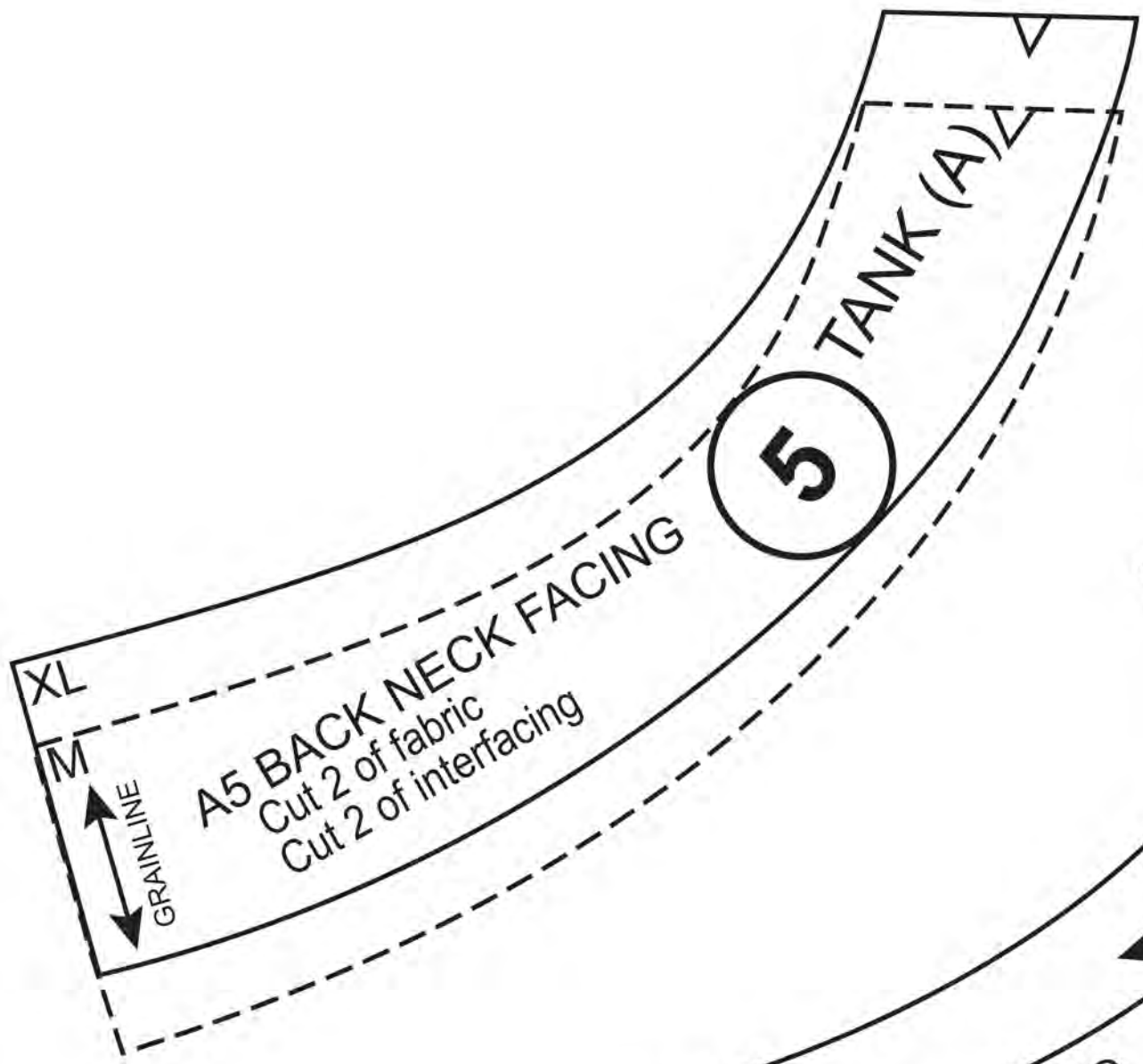

5B

5C

5C

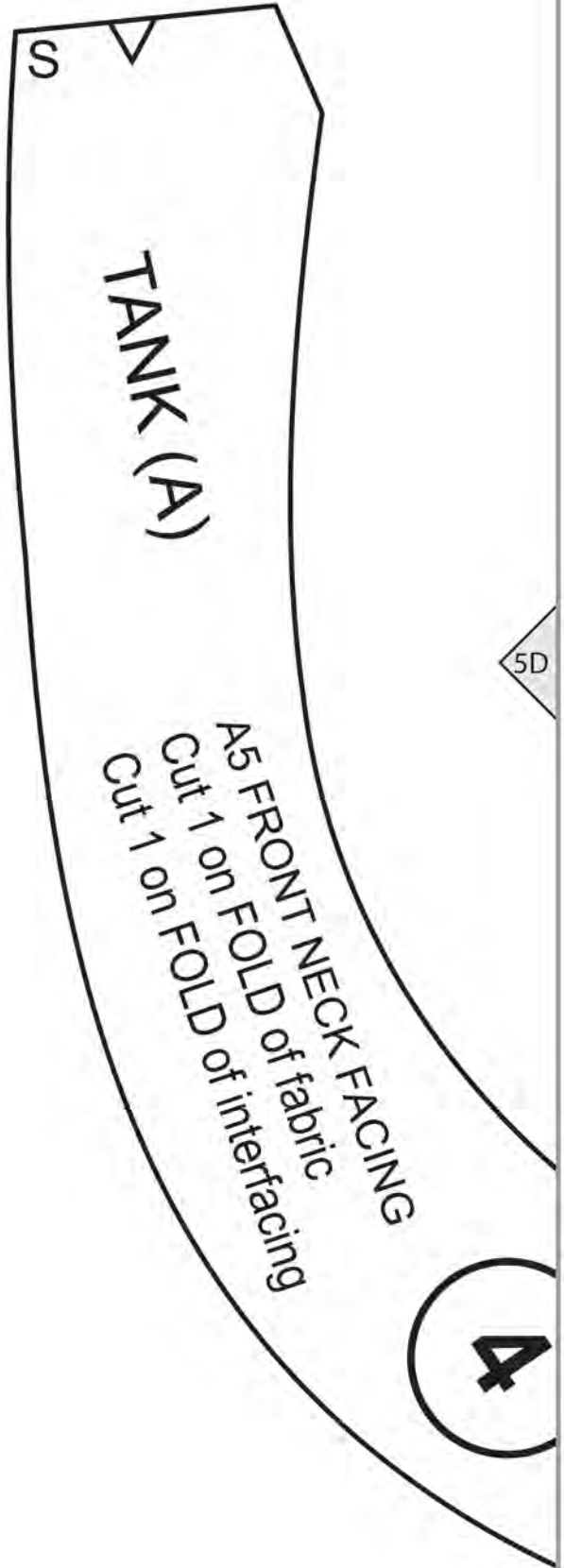
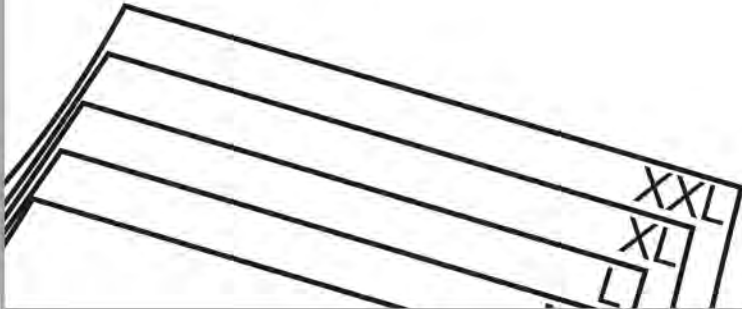
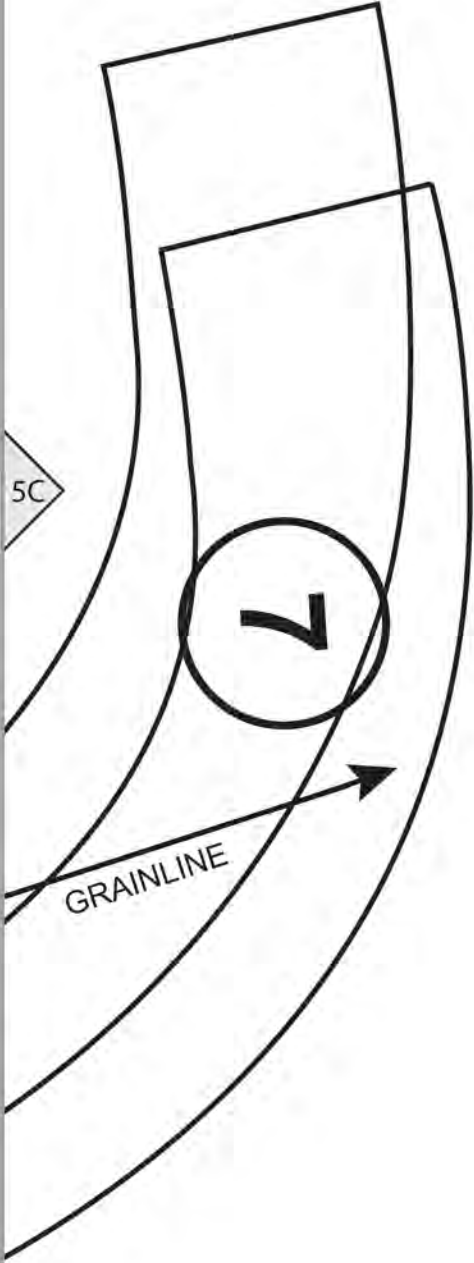

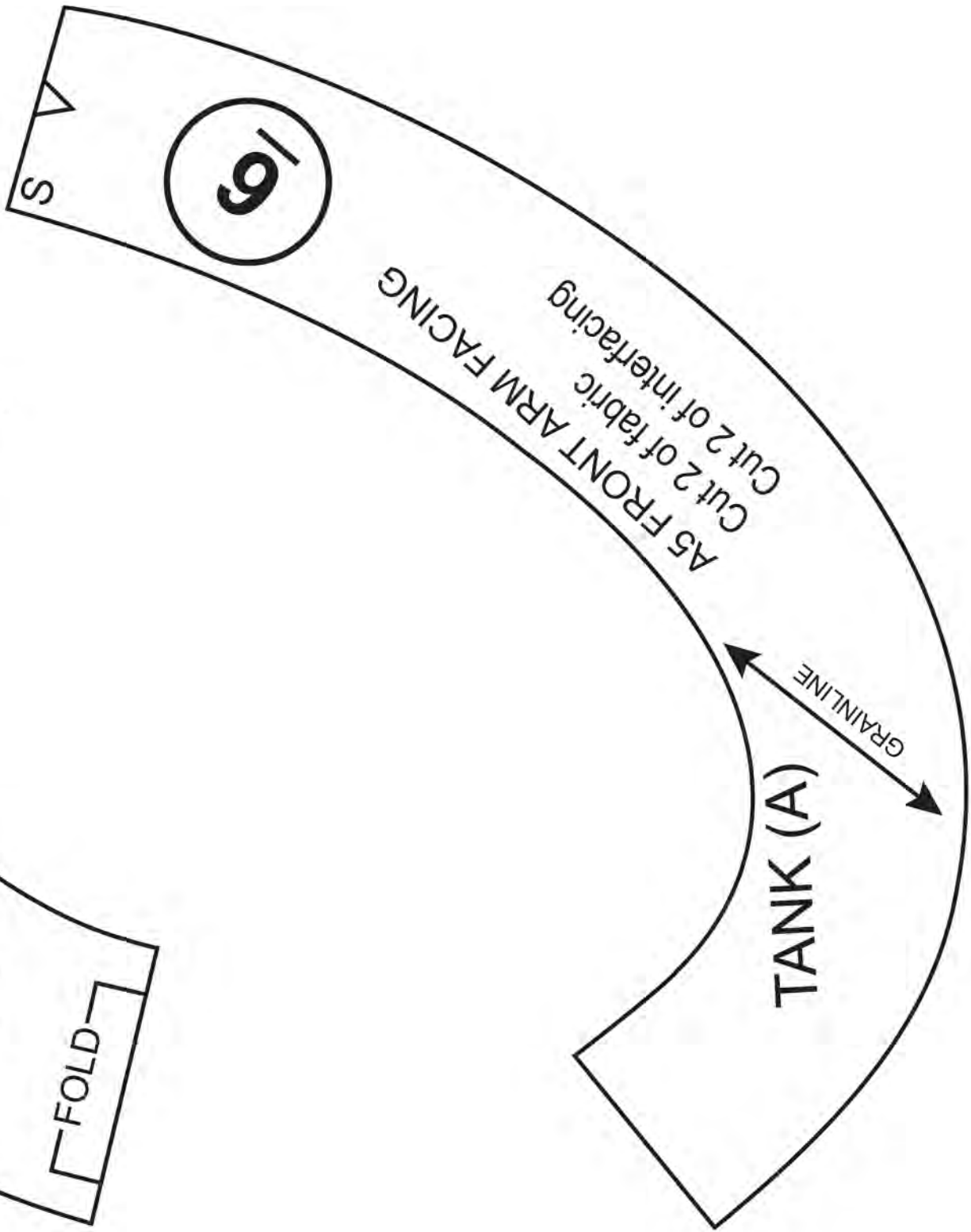

5A

4A

Stitch and fold line



TANK (A)
POCKET
Cut 4

GRAINLINE

4A

XXL

XL

L

M

S

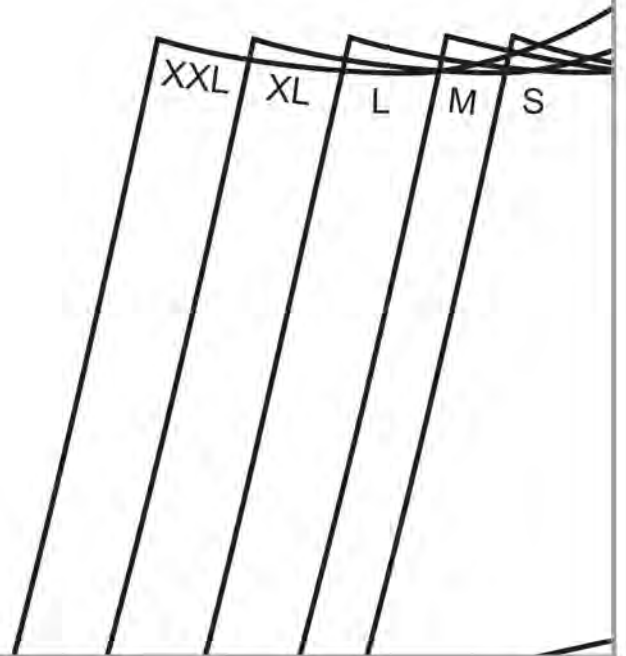

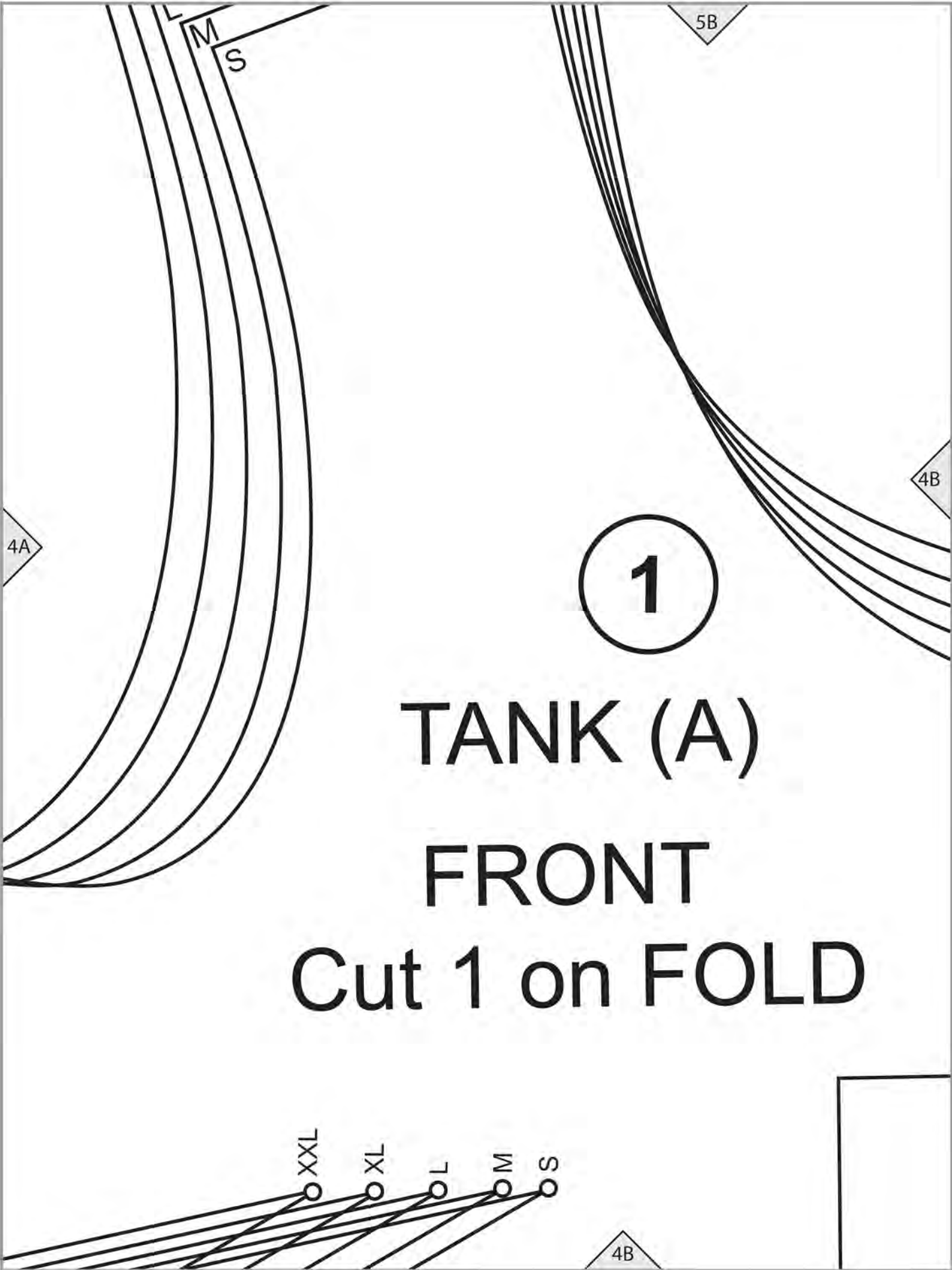

5B

L
M
S

4A

4B

1

TANK (A)

FRONT

Cut 1 on FOLD

XXL
XL
L
M
S

4B

5C

XXL
XL
L
M
S

4C

TANK (A) BACK Cut 2

4B

XXL
XL
L
M
S

Cutting line A5

4C

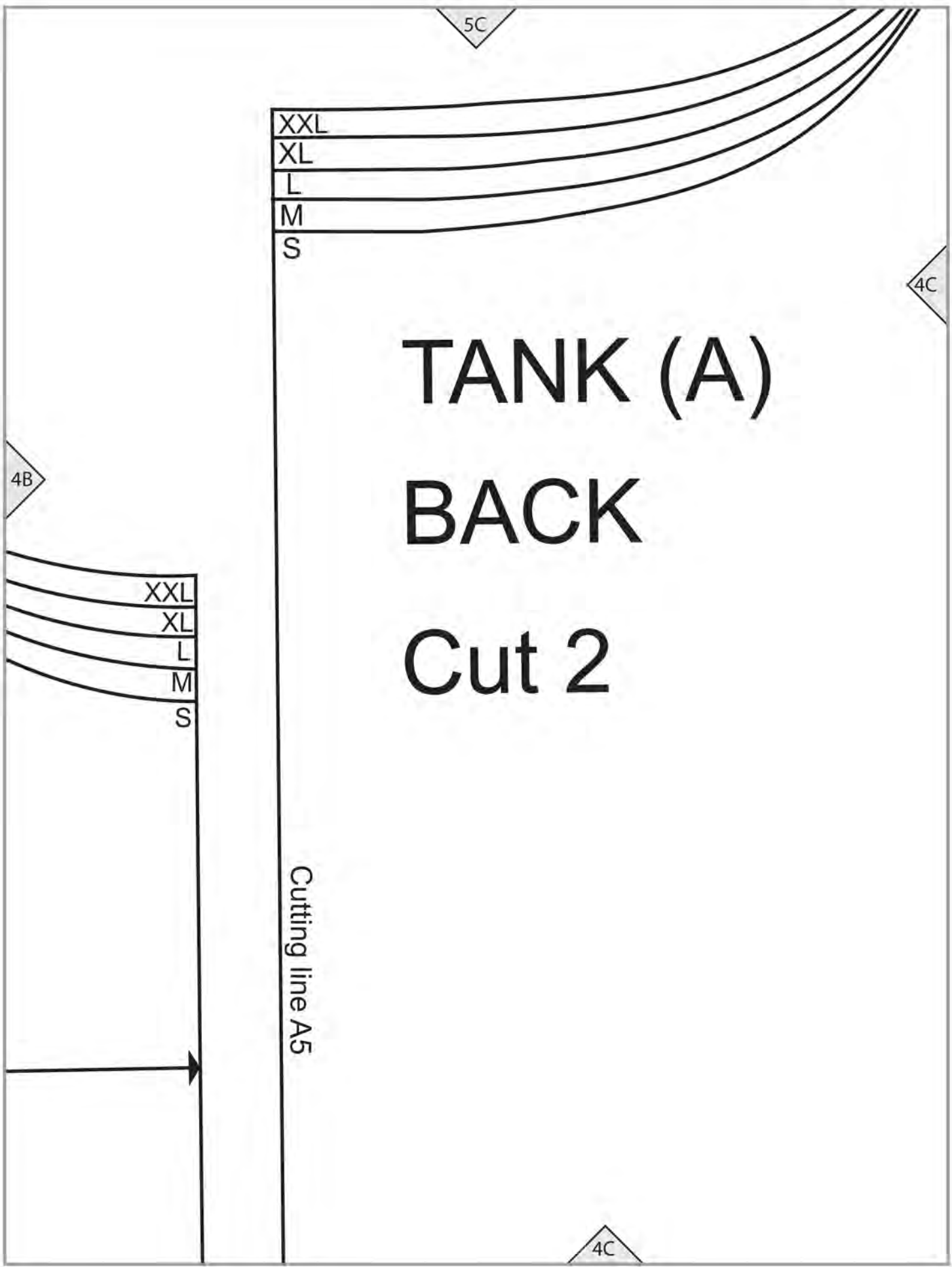

2

4C

S M

5D

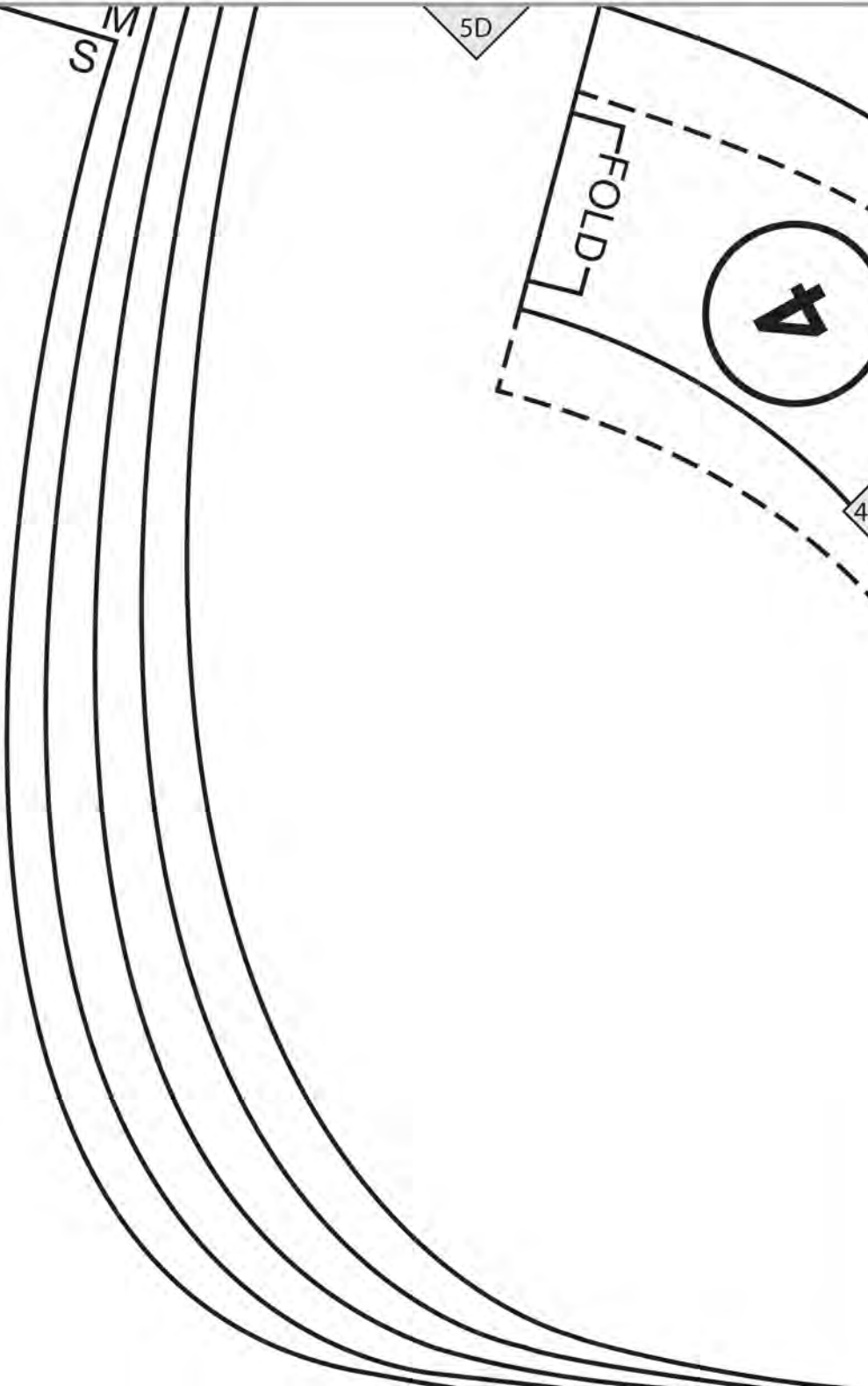
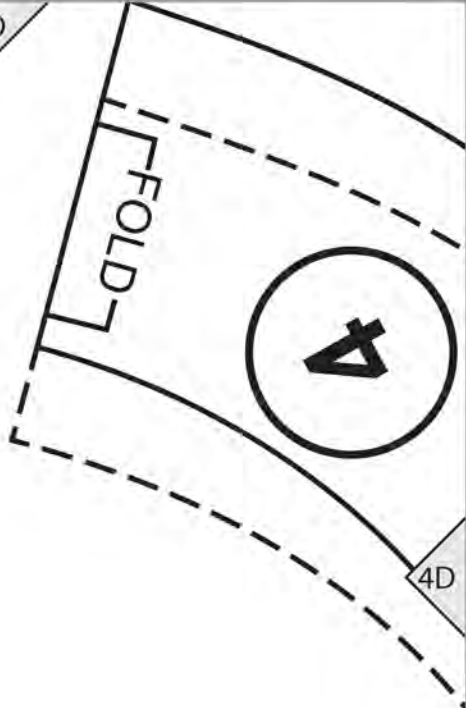

S M L XL XXL

4D

5E

XL

M

TANK (A)

A5 FRONT NECK FACING
Cut 1 on FOLD of fabric
Cut 1 on FOLD of interfacing

4D

A5 FRONT NECK FACING
Cut 1 on FOLD of fabric
Cut 1 on FOLD of interfacing

TANK (A)

L

XXL

4

FOLD

4E

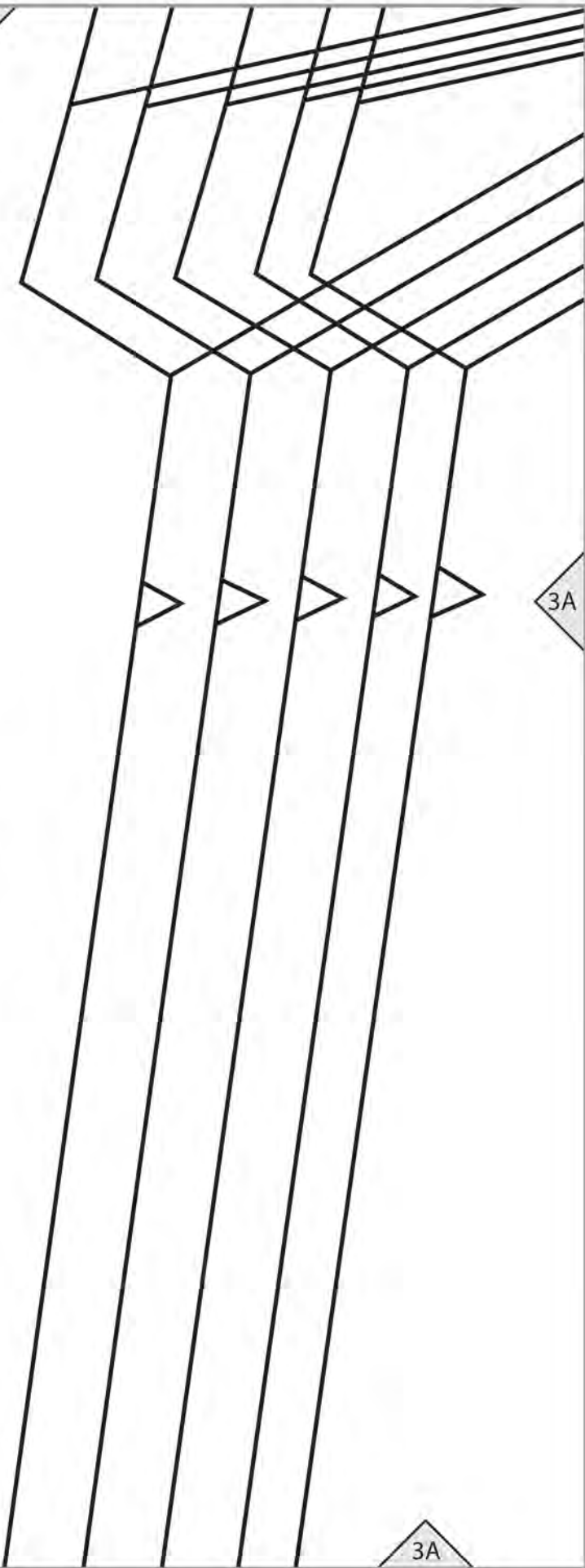
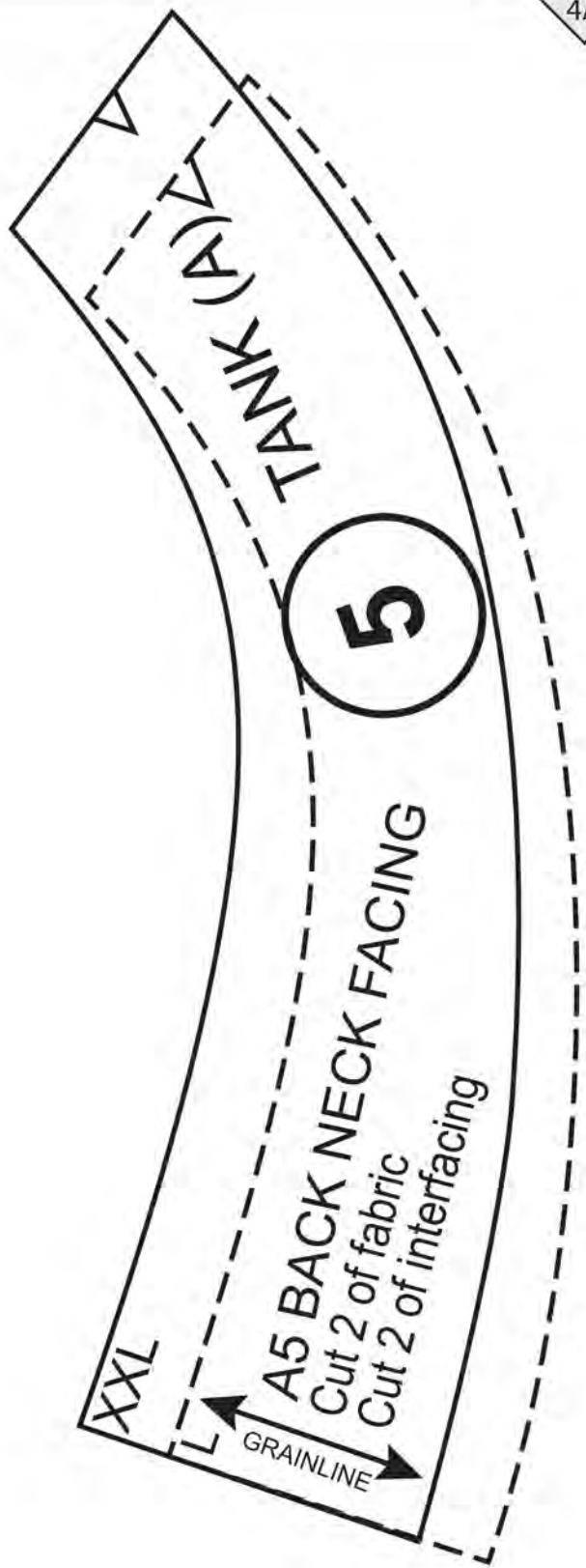

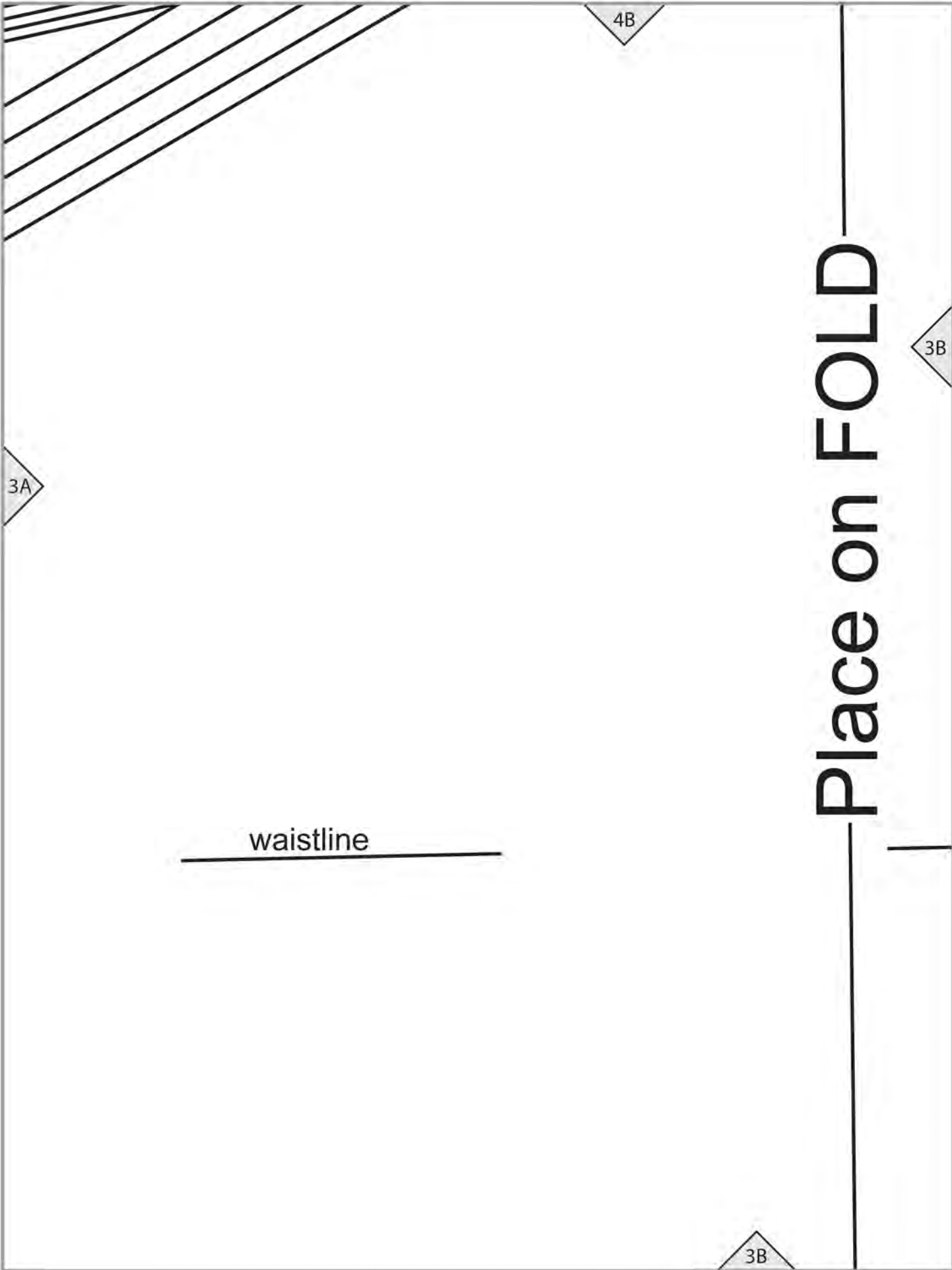

4B

3A

waistline

Place on FOLD

3B

3B

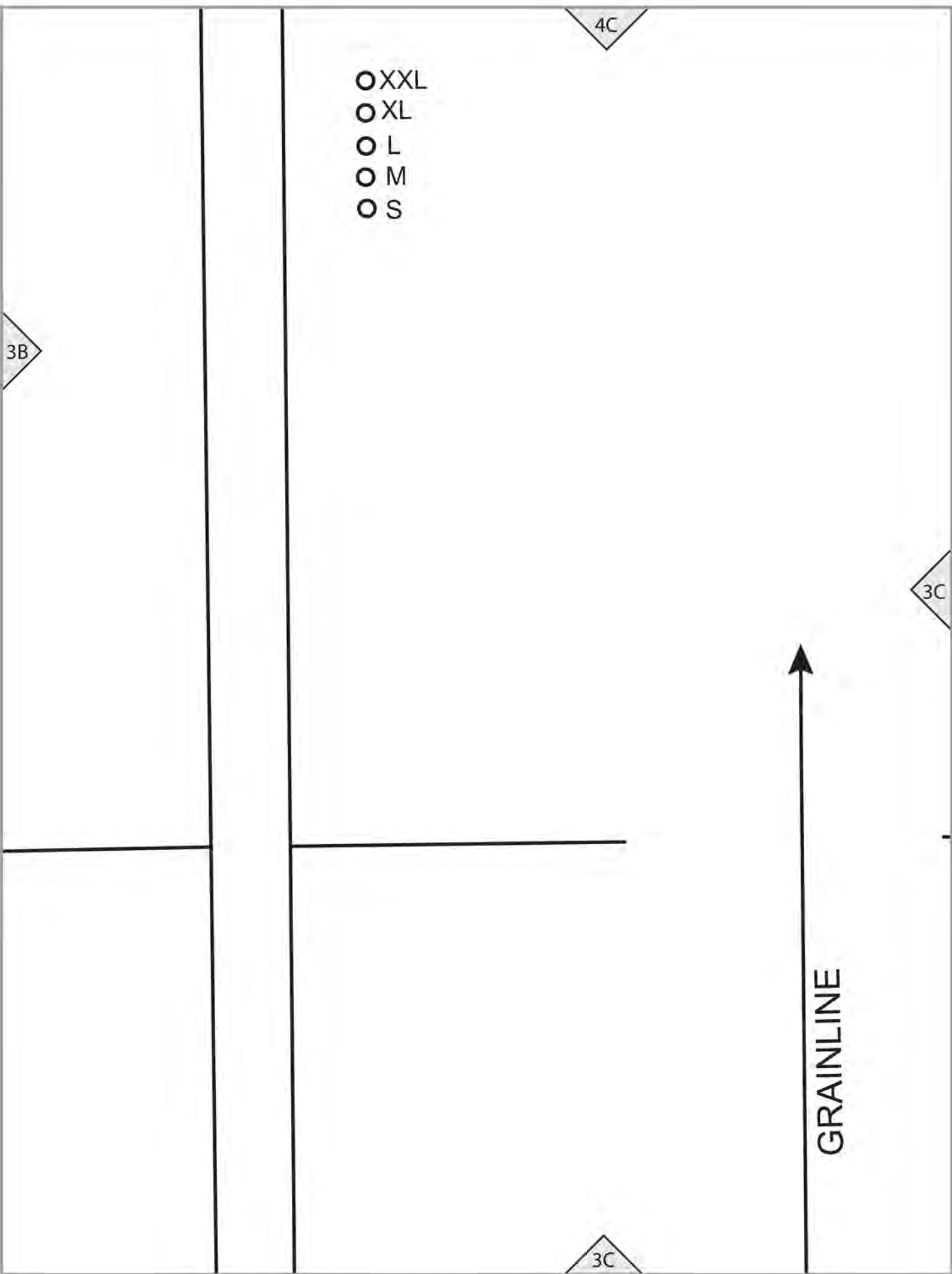

4D

3C

waistline

3D

3D

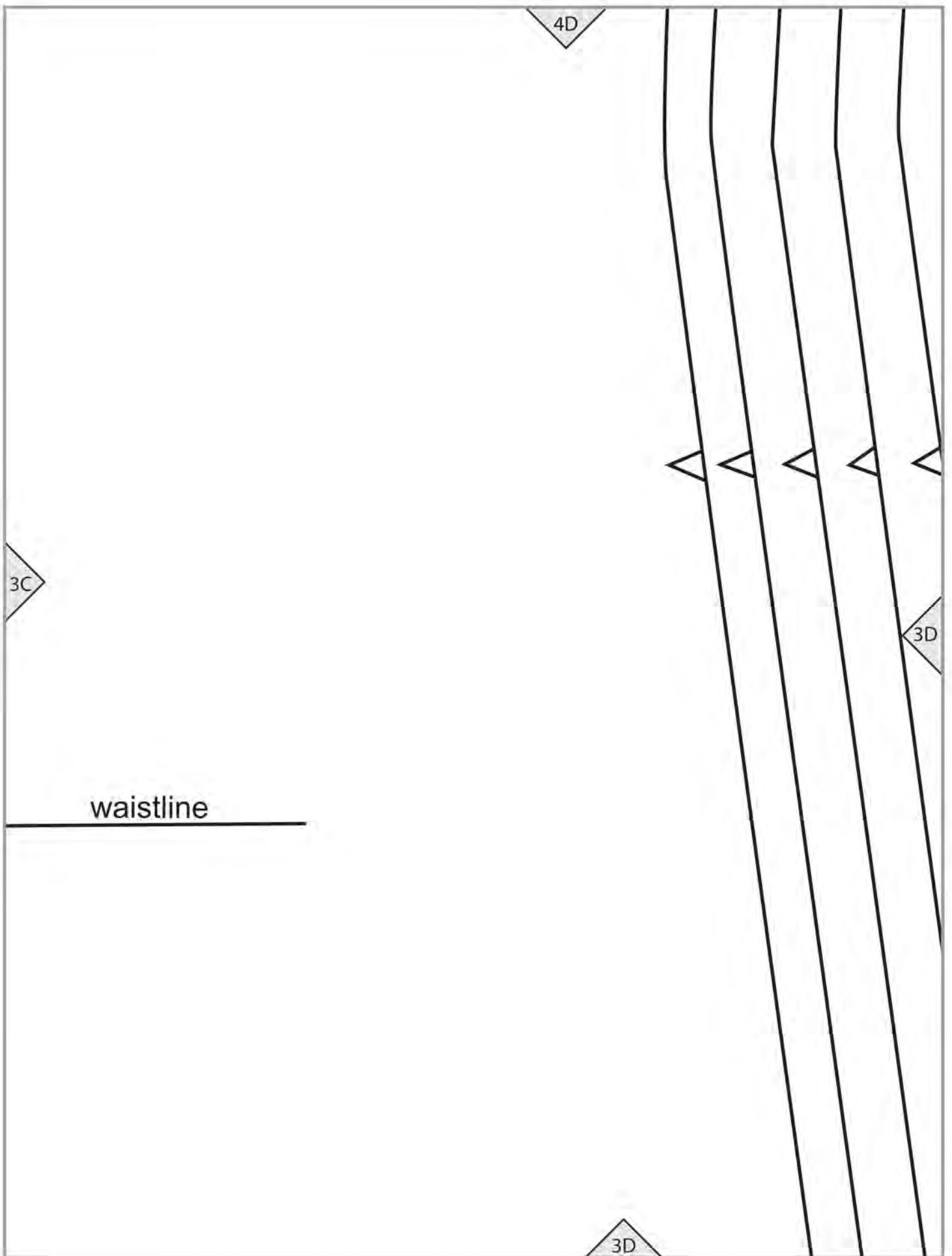

4E

7

GRAINLINE

A5 BACK ARM FACING

Cut 2 of fabric
Cut 2 of interfacing

TANK (A)

S

3D

XL

M

A5 BACK ARM FACING
Cut 2 of fabric
Cut 2 of interfacing

3E

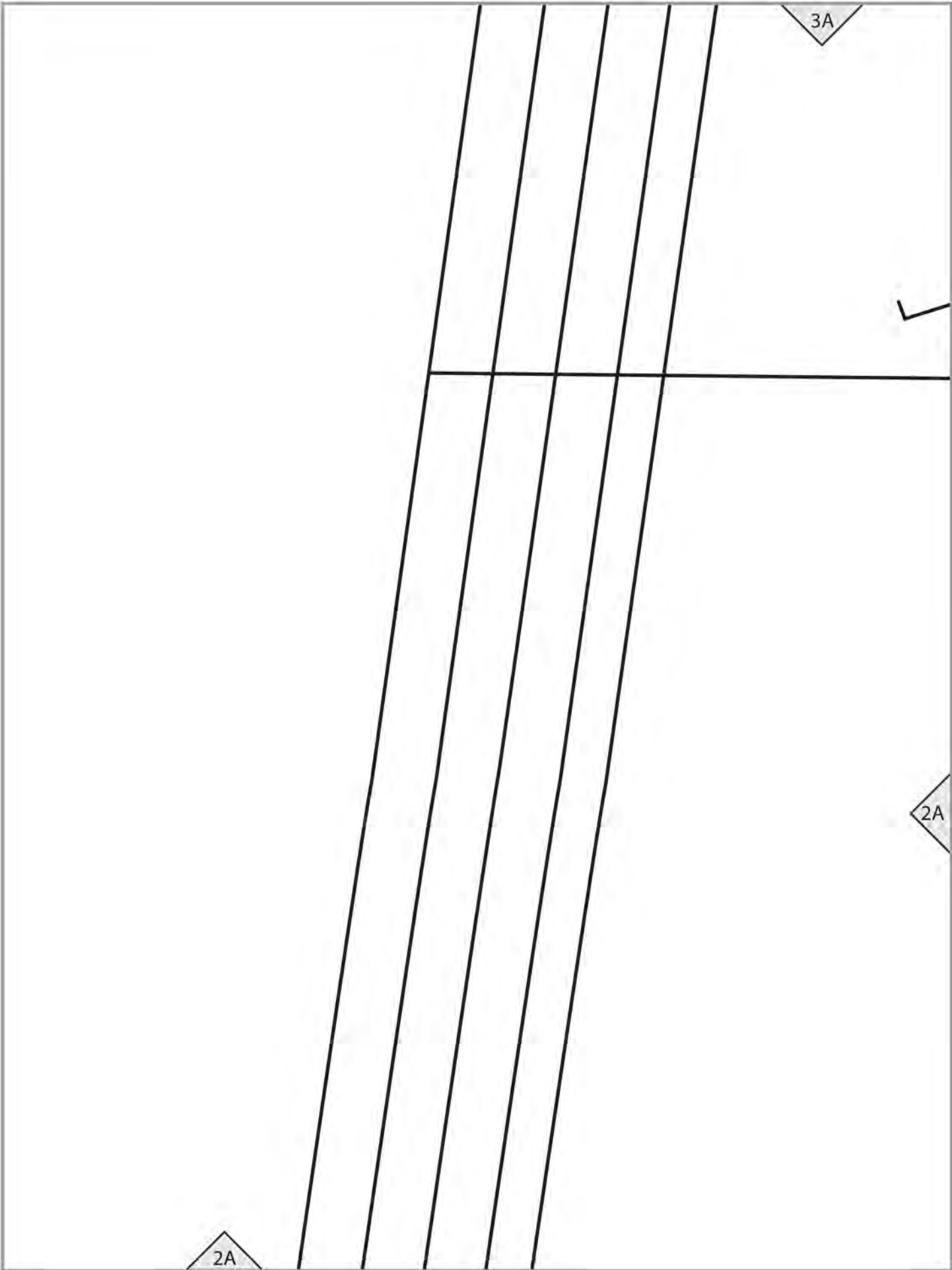

2A

3A

2A



A5 POCKET PLACEMENT LINE (adjust to fit)

3B

lengthen/shorten line

2A

2B

2B

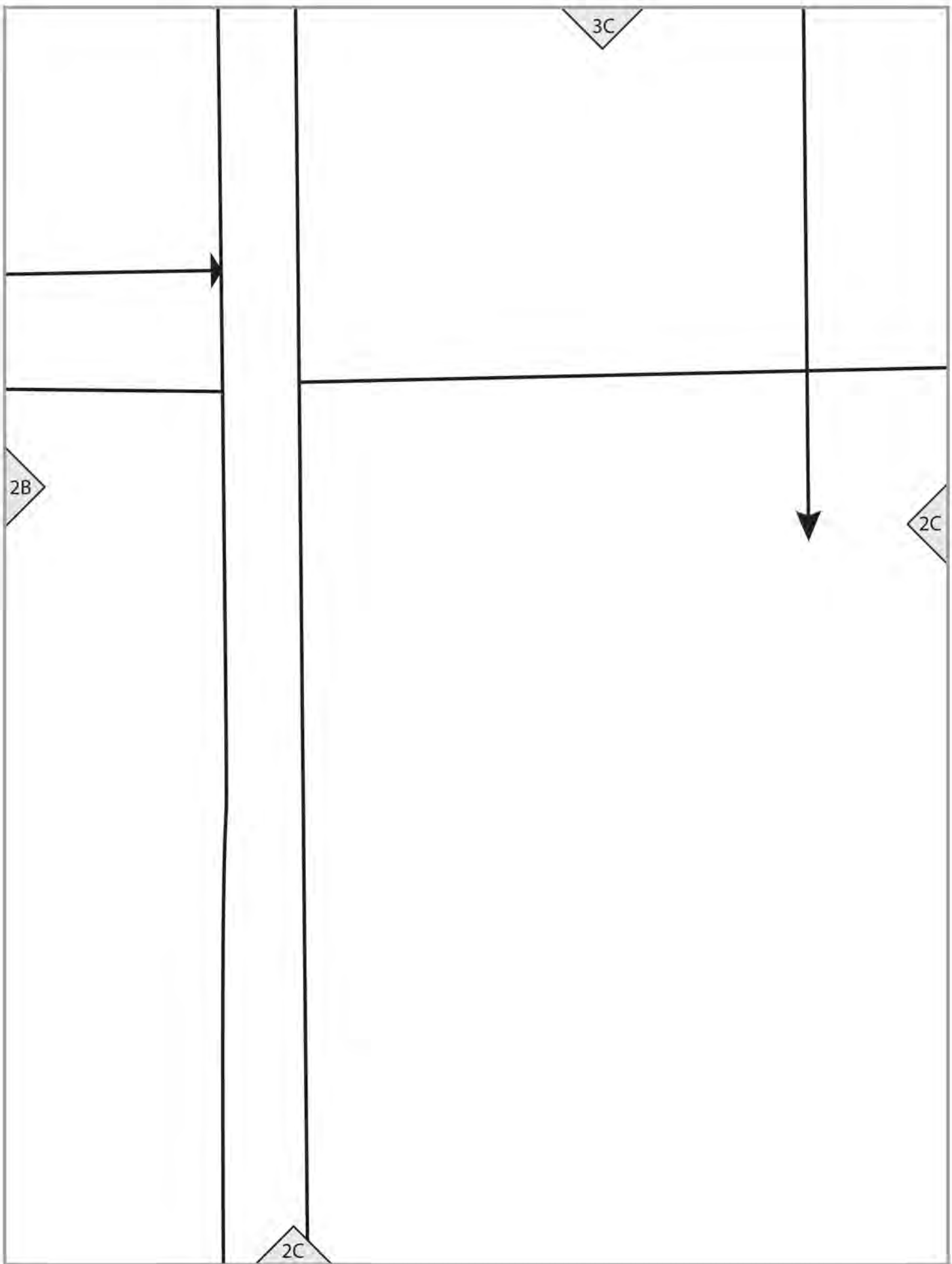

3D

lengthen/shorten line

2C

2D

THE **MAGIC**  **PATTERN** BOOK

BY AMY BARICKMAN

workman

workman.com

ABIGAIL (A5)

TEST SQUARE

4" (10 cm)

2D

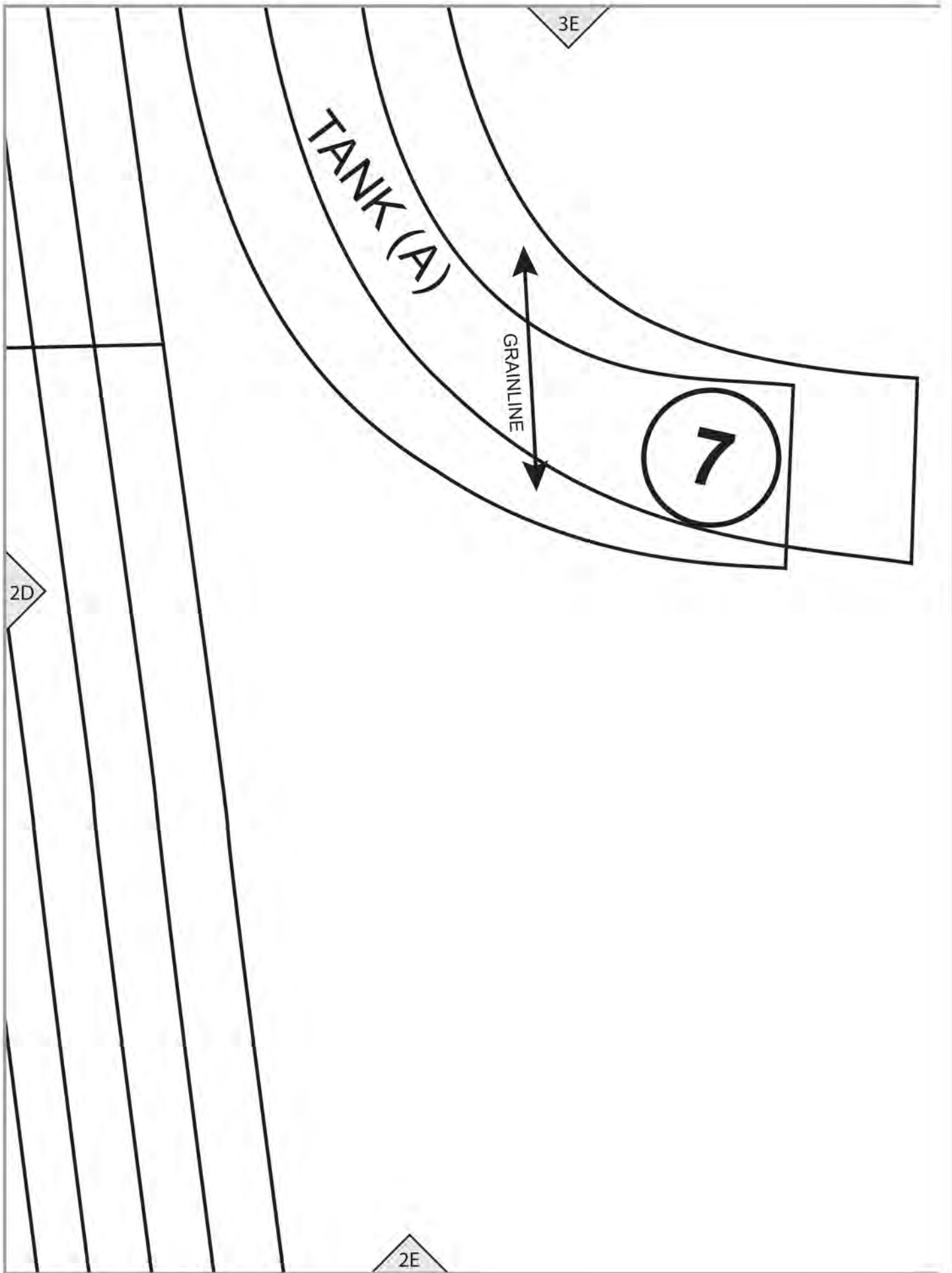

2A

1A

XXL XL L M S

A5 cutting line

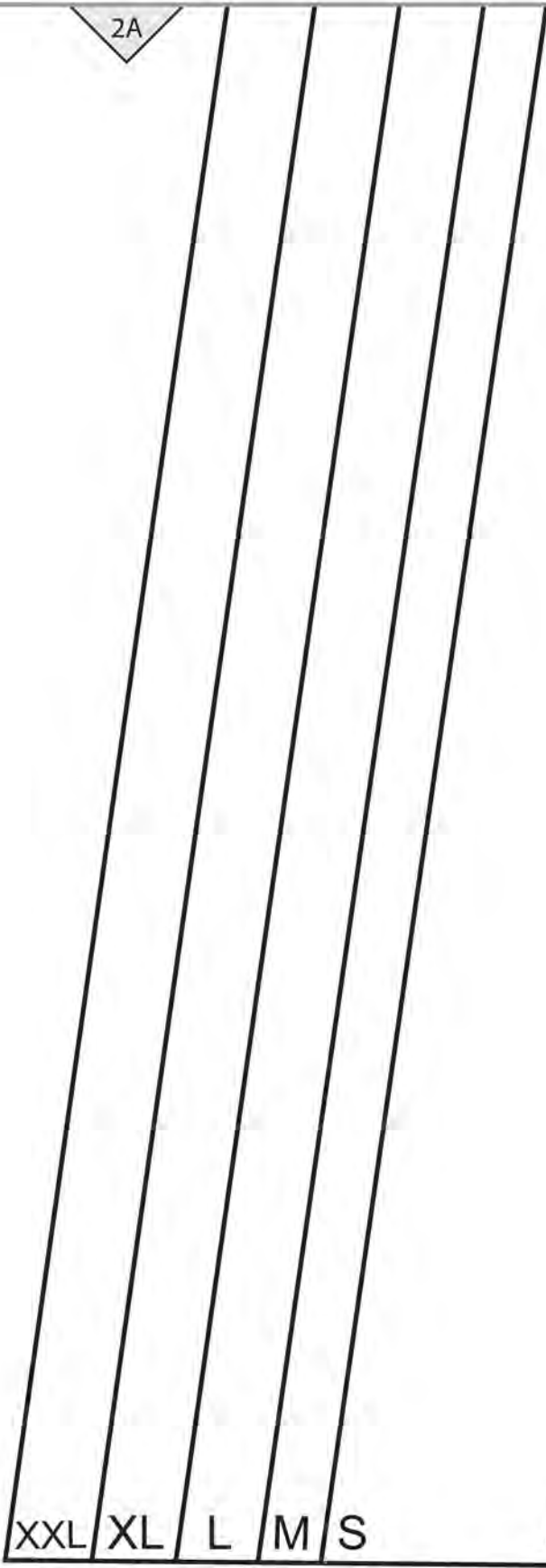

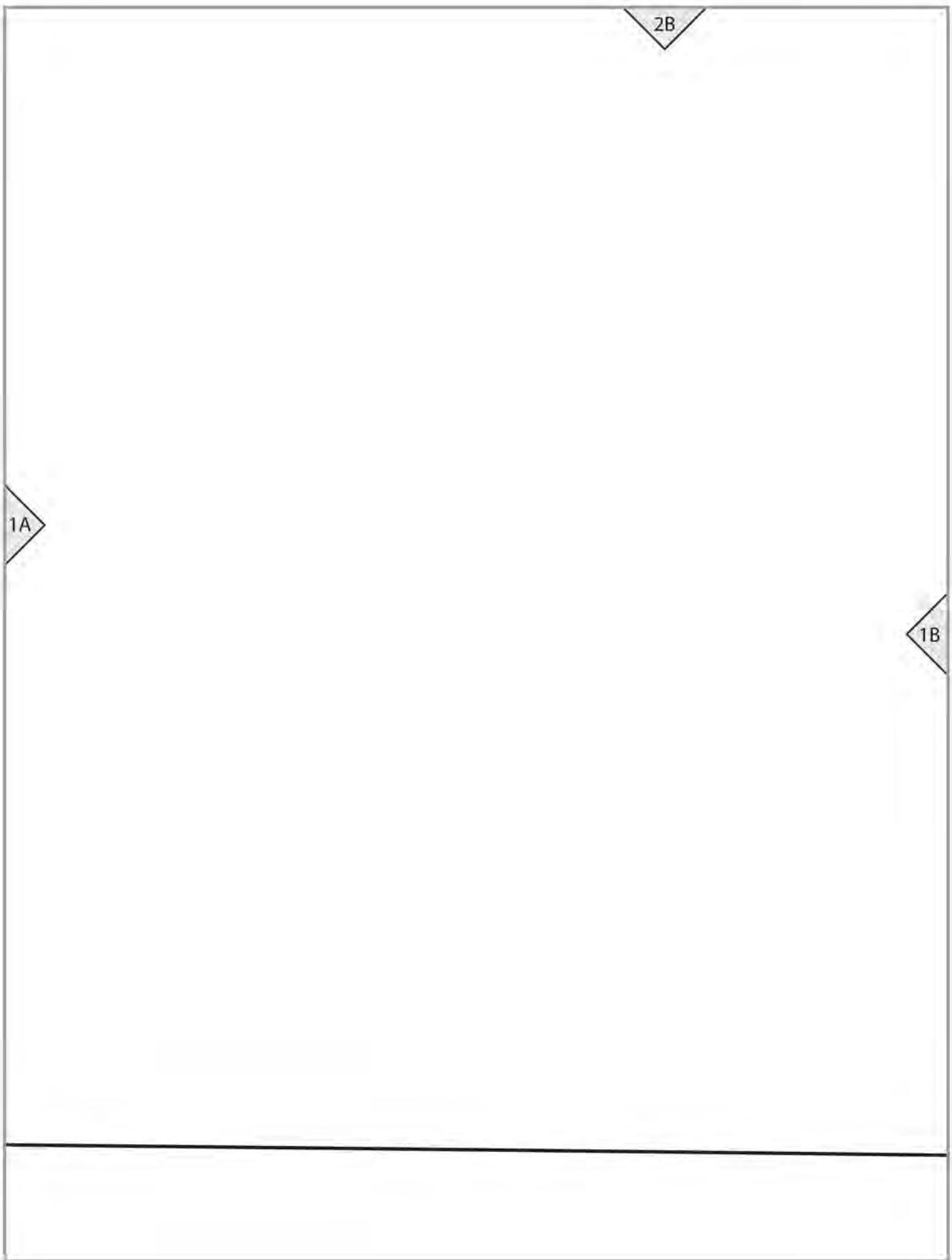

2B

1A

1B

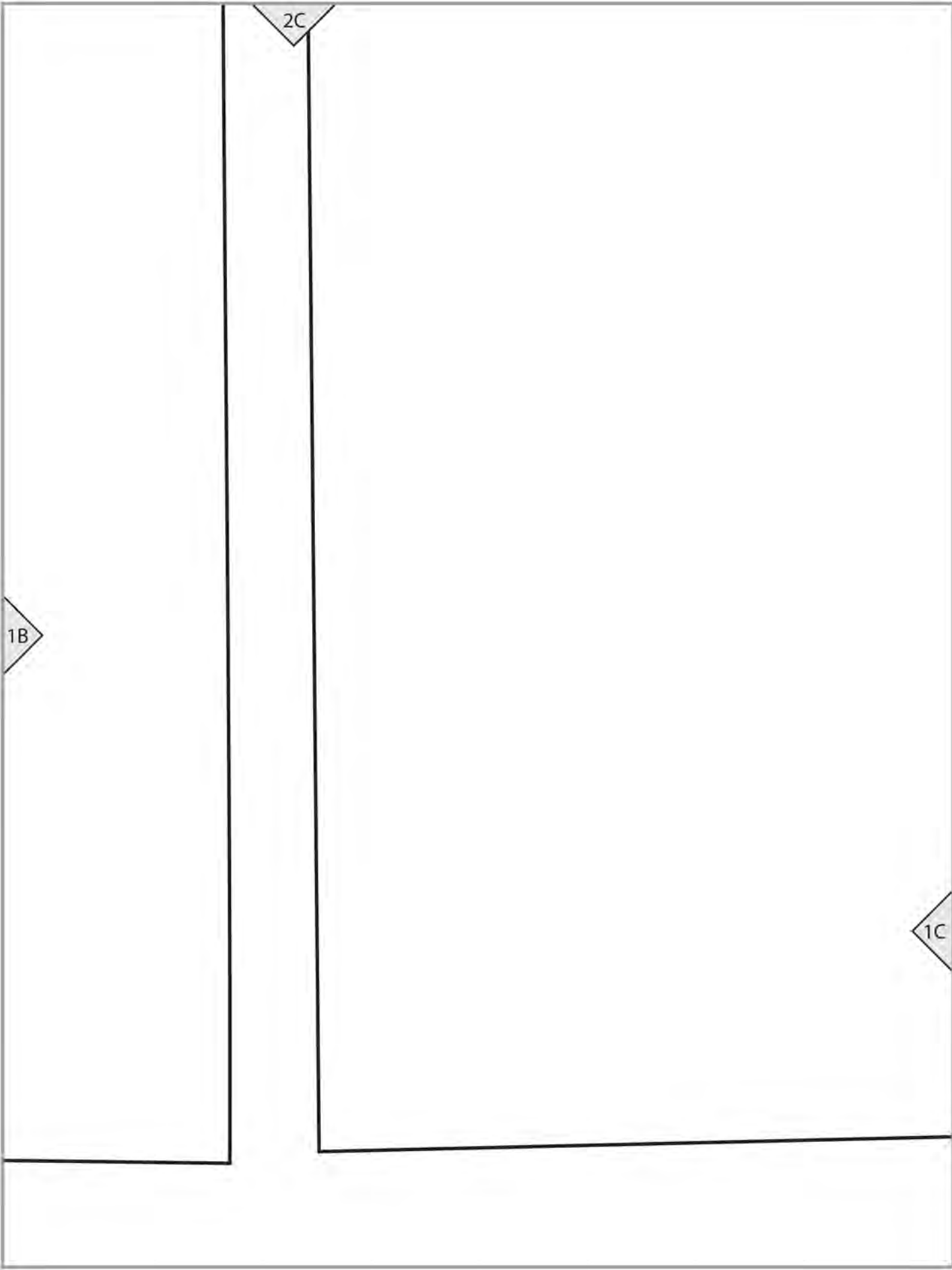

1B

2C

1C

2D

1D

1C

A5 cutting line

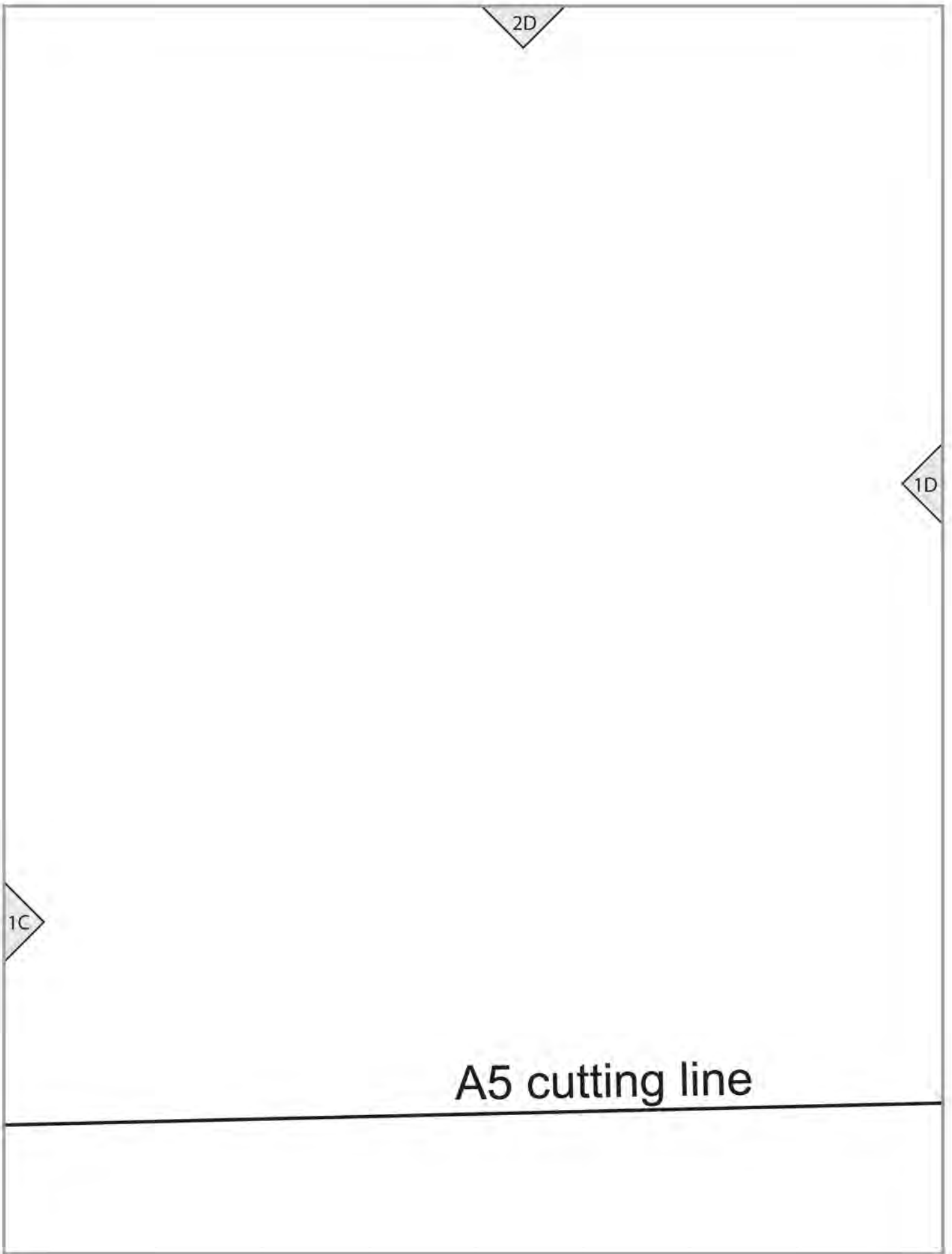

2E

GRAINLINE

S

A5 BACK NECK FACING
Cut 2 of fabric
Cut 2 of interfacing

5

TANK (A)

S M L XL XXL

1D