

A4. Alma

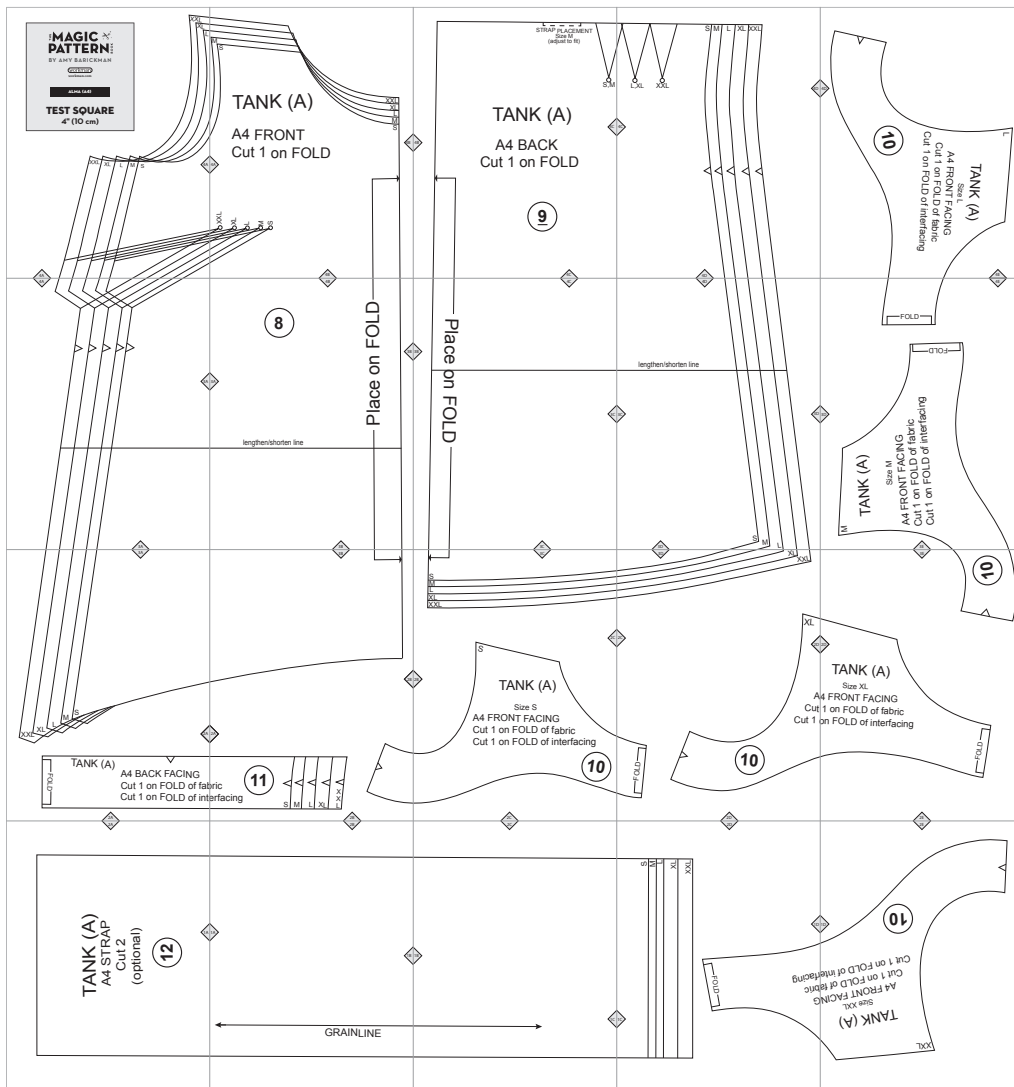

Copyright ©2014 by Amy Barickman

All rights reserved. Amy Barickman's patterns may be printed for personal use, but may not be otherwise reproduced—mechanically, electronically, or by any other means, including photocopying—without written permission of the publisher.

Sewing pattern designs for *The Magic Pattern Book* by Amy Barickman are intended for personal use only, and not as the basis for commercial manufacturing.

Workman Publishing, New York • workman.com

THE **MAGIC** 
PATTERN BOOK

BY AMY BARICKMAN

workman
workman.com

ALMA (A4)

TEST SQUARE
4" (10 cm)

XXL
XL
L

XXL XL L M S

4A

4A

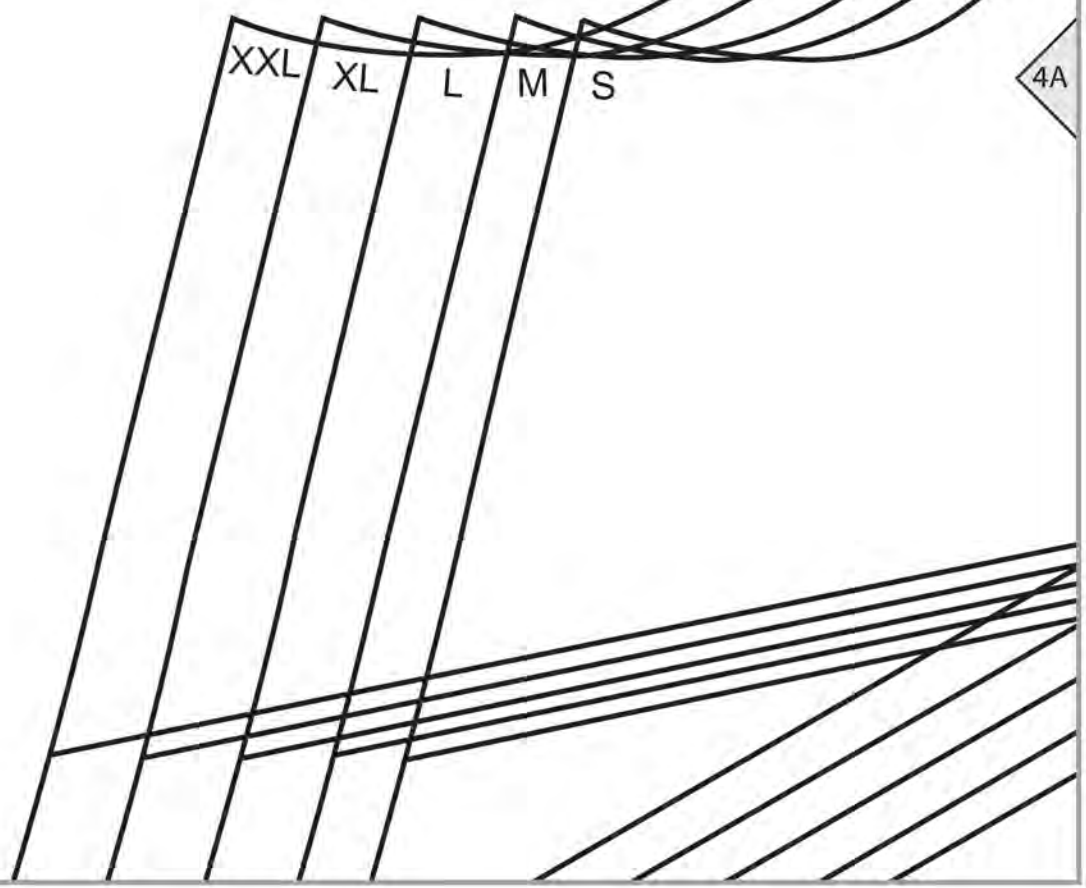

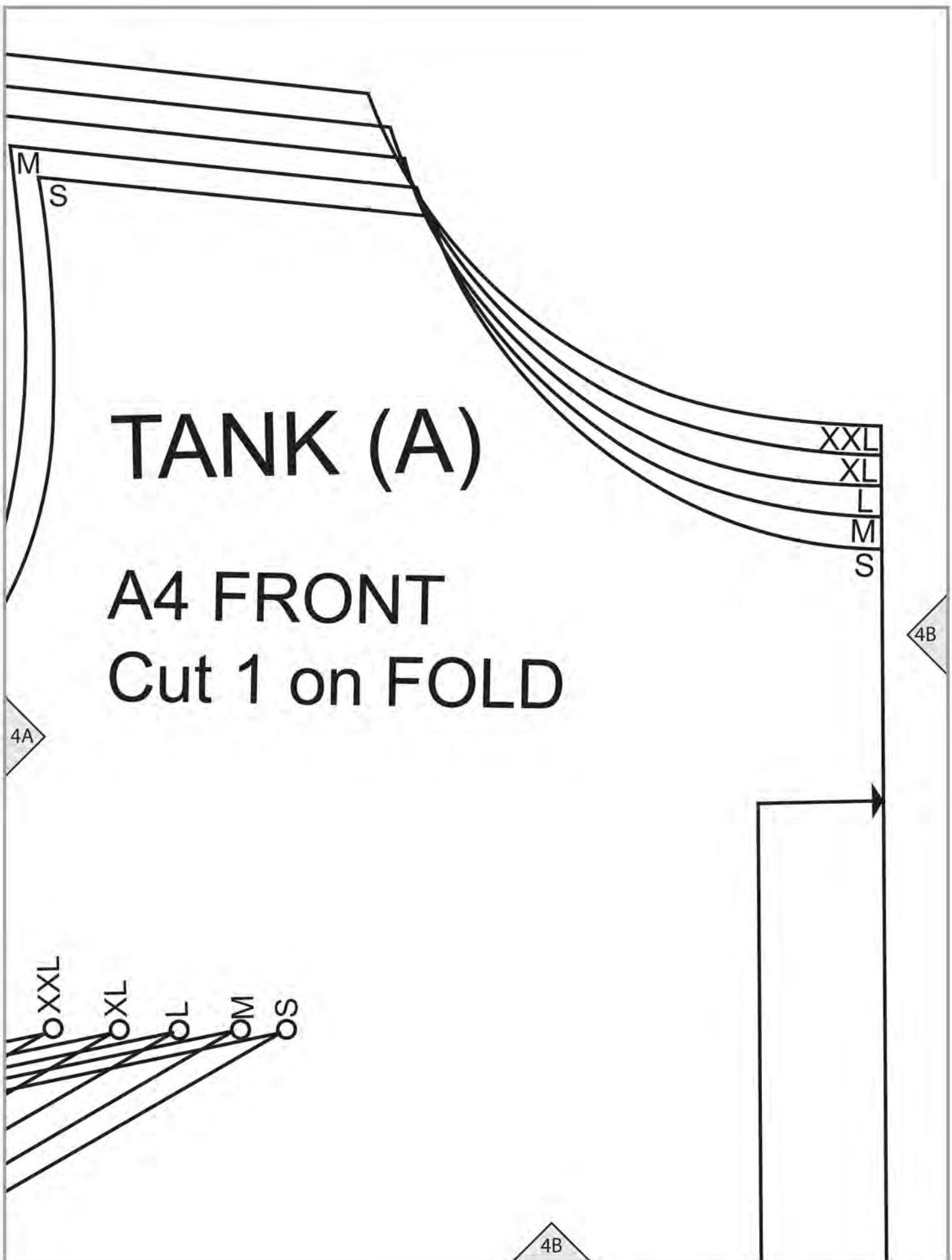

TANK (A)

A4 FRONT
Cut 1 on FOLD

M
S

XXL
XL
L
M
S

4A

4B

XXL
XL
L
M
S

4B

STRAP PLACEMENT
Size M
(adjust to fit)

S, M

TANK (A)

A4 BACK
Cut 1 on FOLD

9

4B

4C

4C

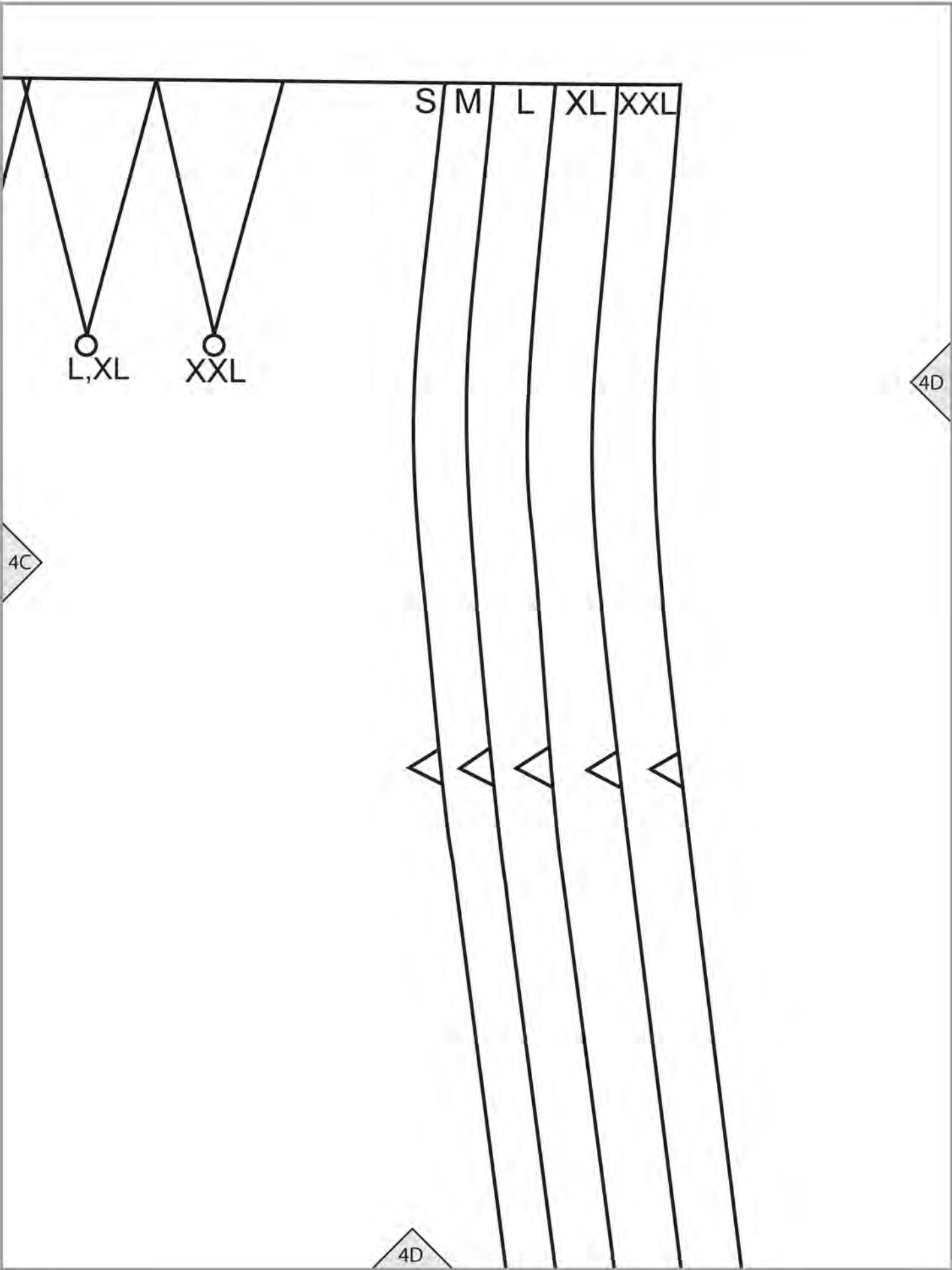

L, XL

XXL

S

M

L

XL

XXL

4C

4D

4D

L

TANK (A)

Size L

A4 FRONT FACING

Cut 1 on FOLD of fabric

Cut 1 on FOLD of interfacing

10

4D

4E

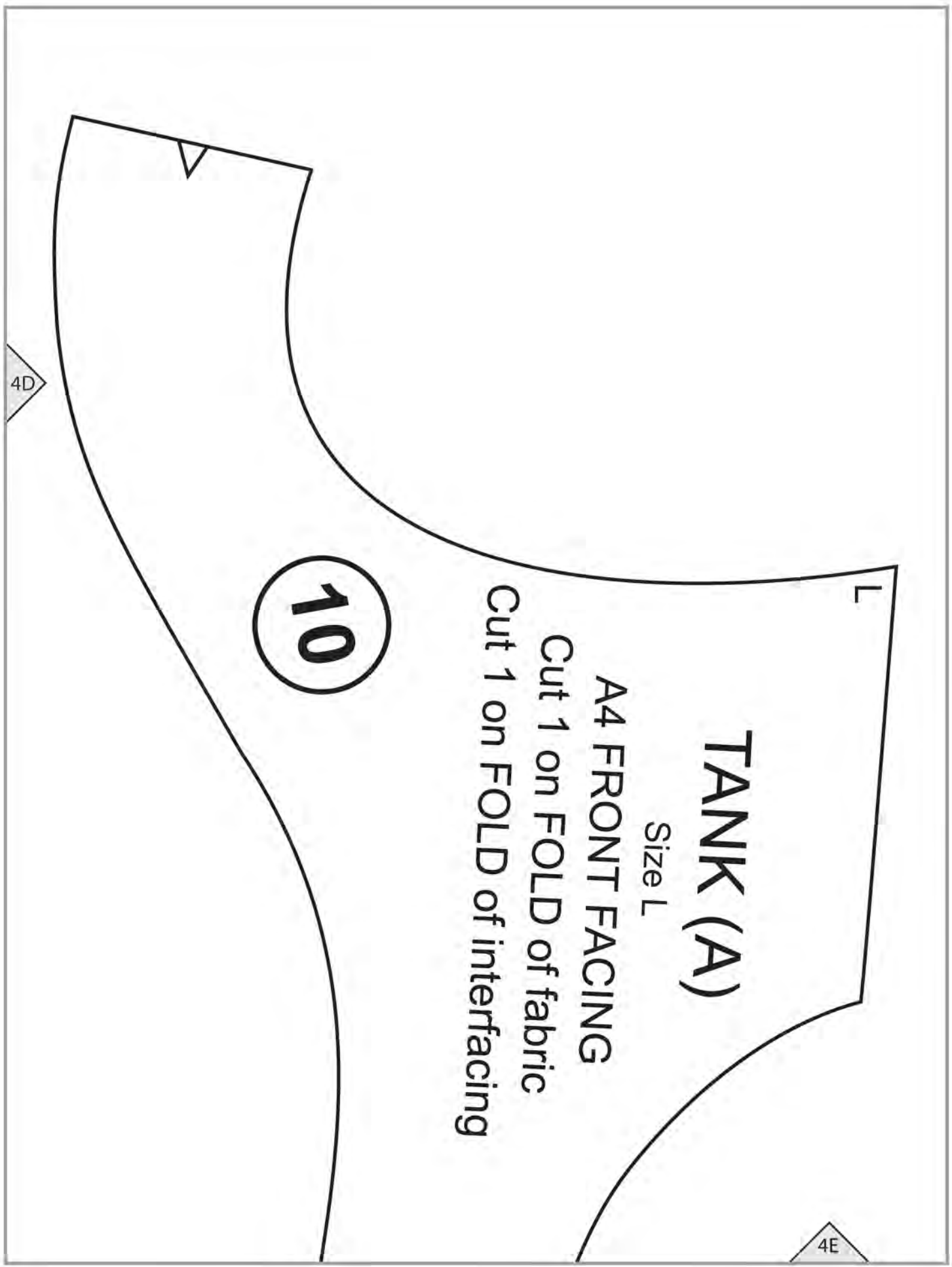

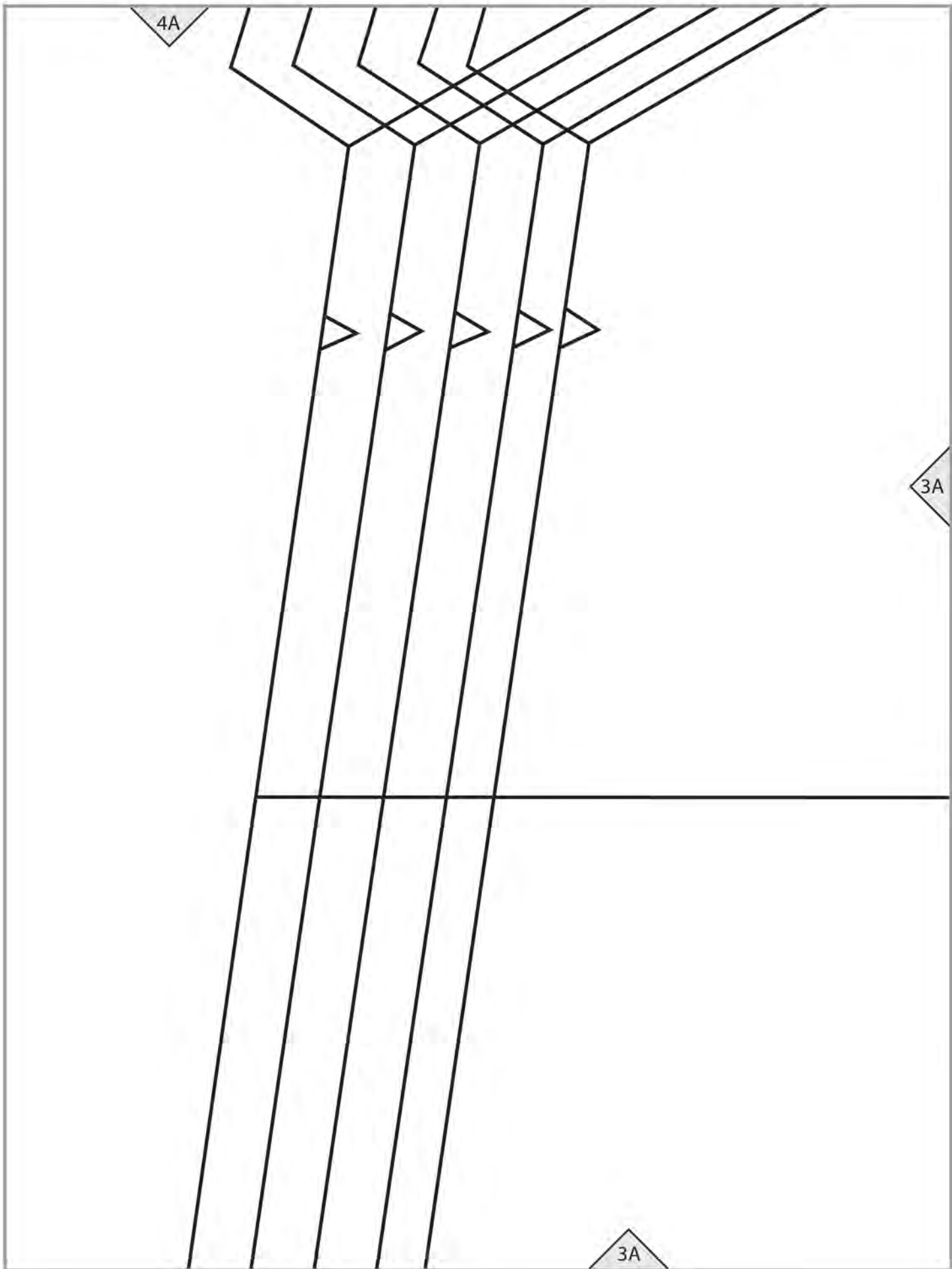

8

4B

3A

3B

Place on FOLD

lengthen/shorten line

3B

4C

Place on FOLD

3B

3C

3C

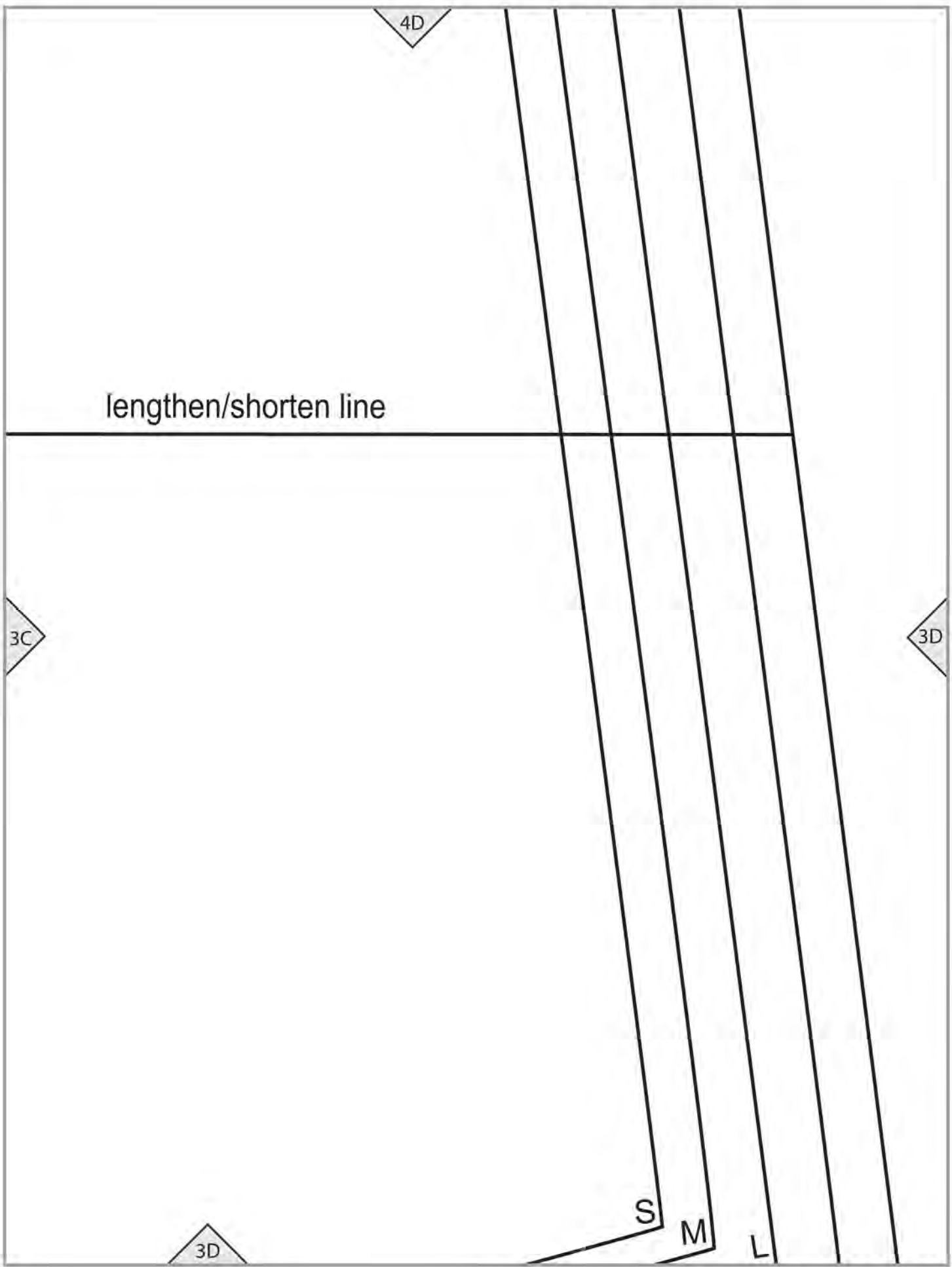

4E

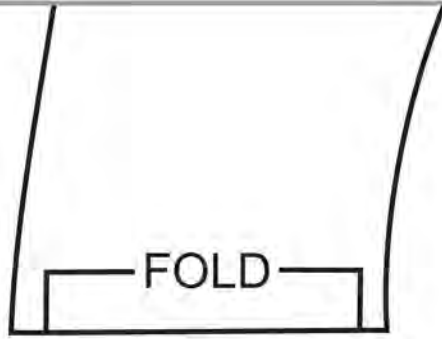

3D

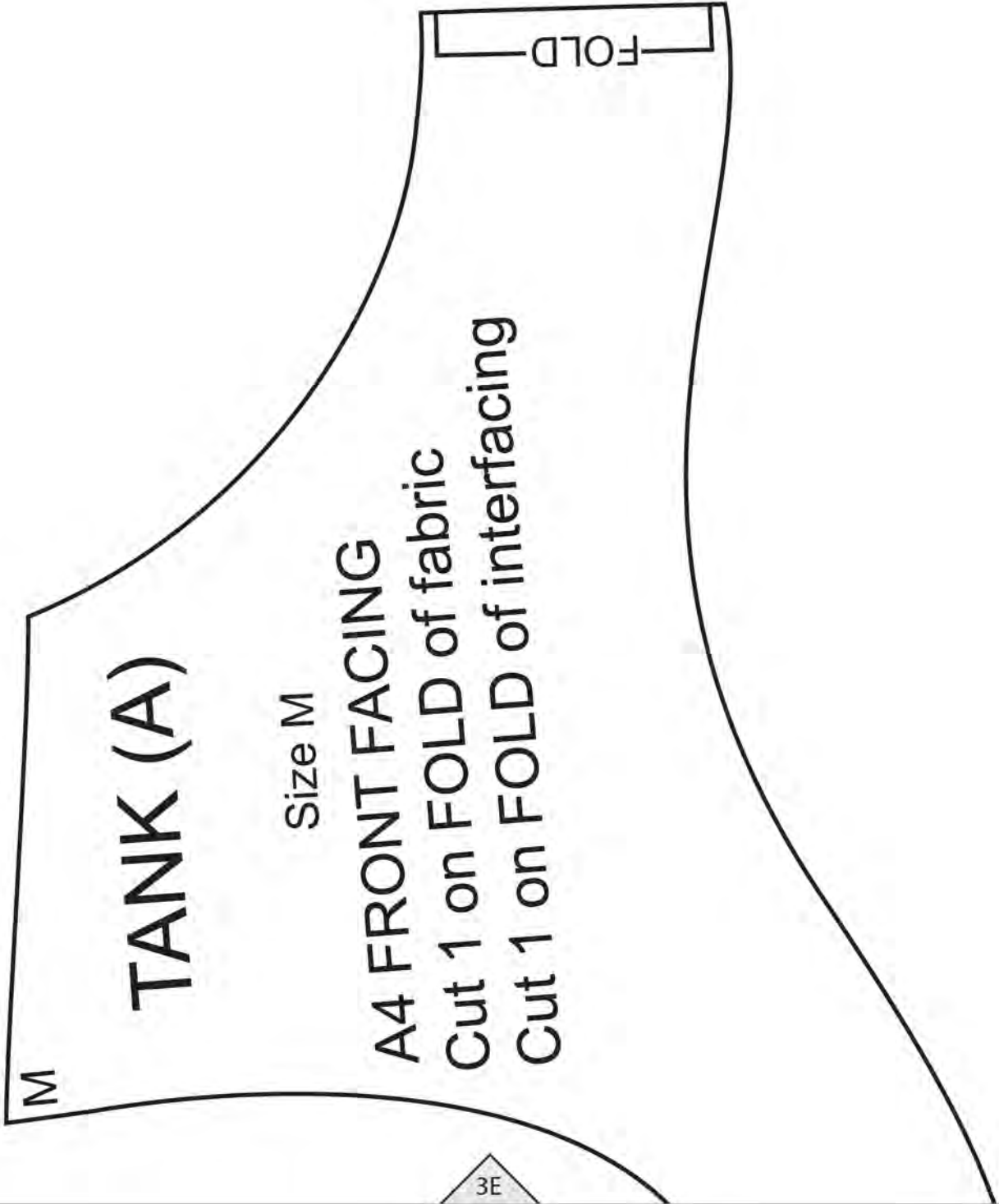

TANK (A)

Size M

A4 FRONT FACING

Cut 1 on FOLD of fabric

Cut 1 on FOLD of interfacing

3E

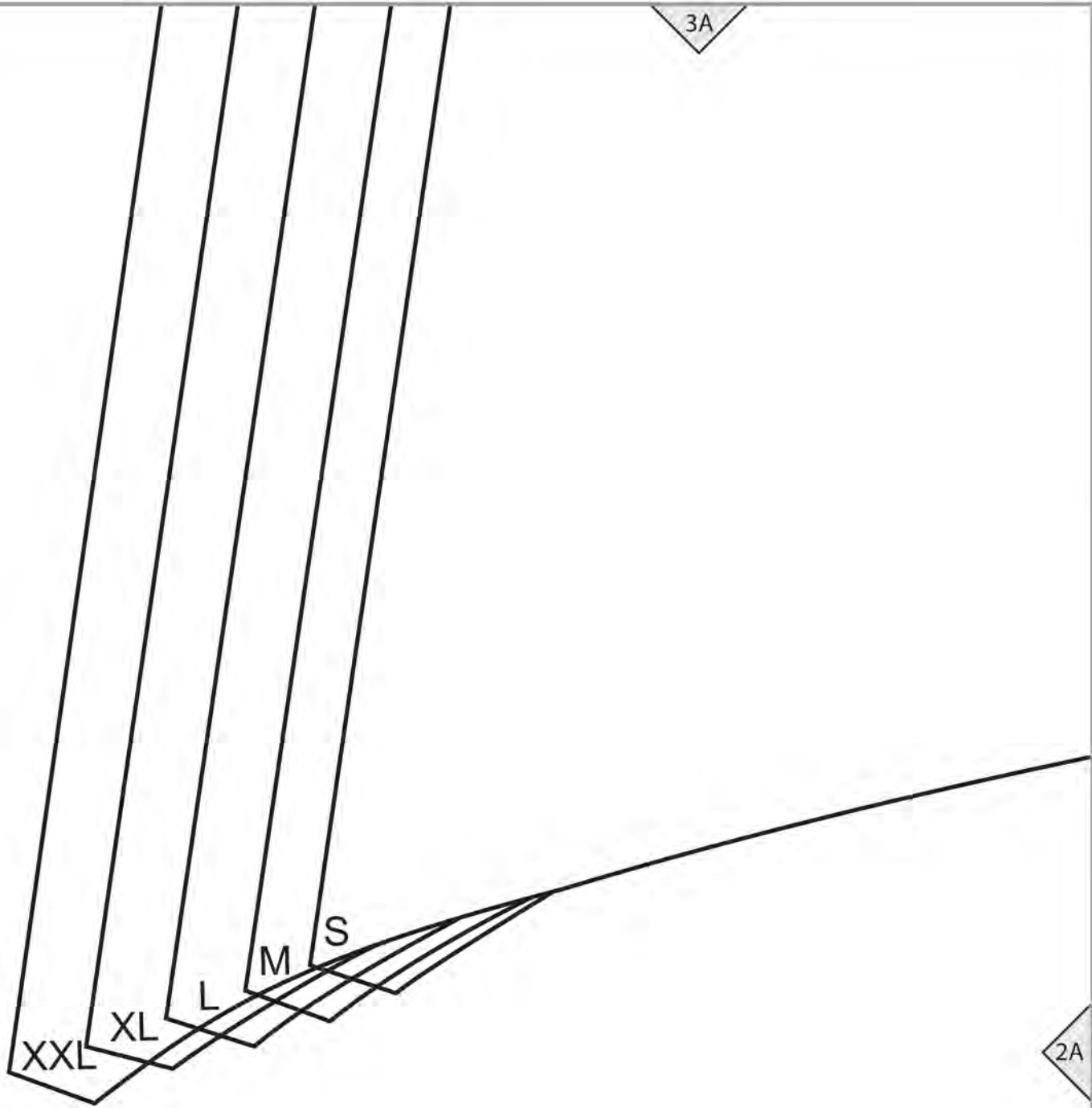

TANK (A)

A4 BACK FACING
Cut 1 on FOLD of fak
Cut 1 on FOLD of int

FOLD

2A

3B

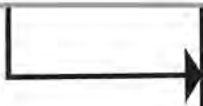

2B

2A

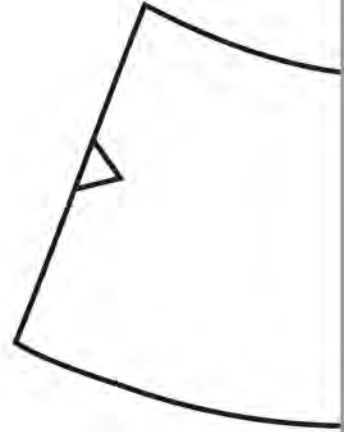
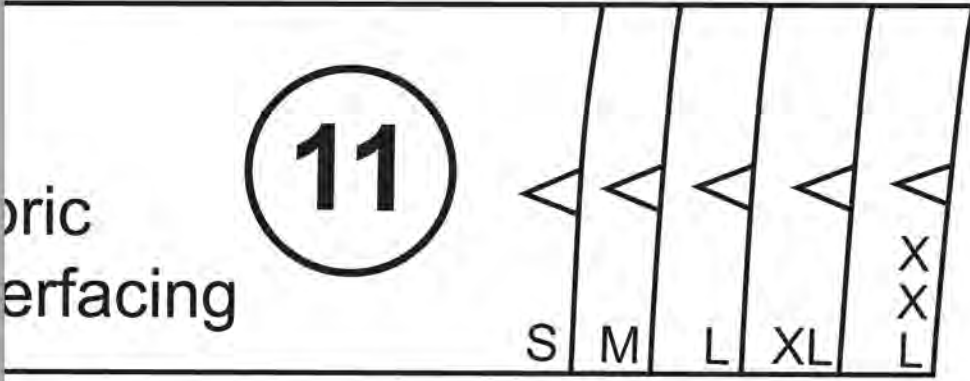

2B

S
M
L
XL
XXL

3C

2C

2B

S

TANK (A)

Size S

A4 FRONT FACING
Cut 1 on FOLD of fabric
Cut 1 on FOLD of interfacing

10

2C

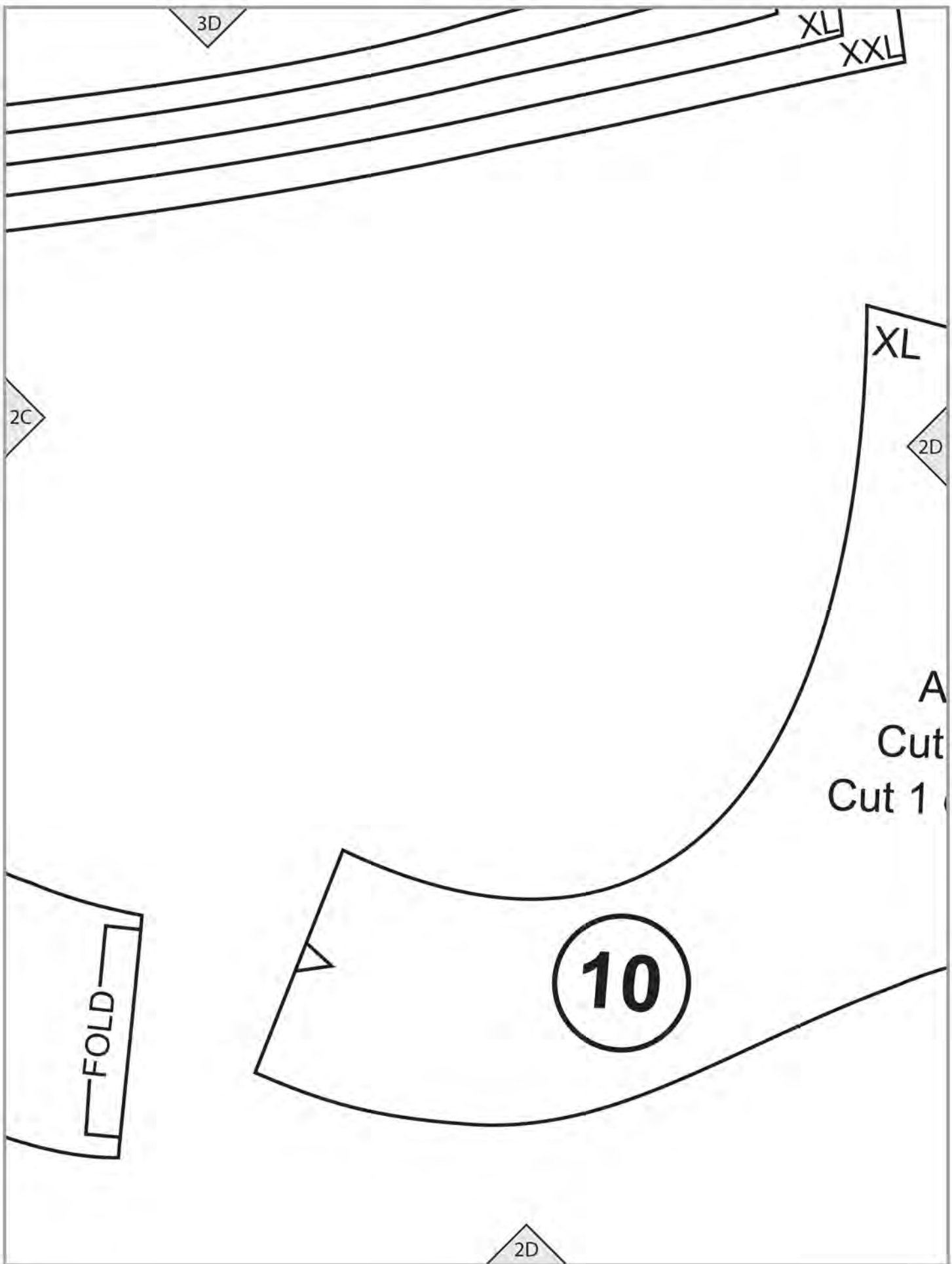

3E

10

2D

TANK (A)

Size XL

4 FRONT FACING
1 on FOLD of fabric
on FOLD of interfacing

FOLD

2E

TANK (A)
A4 STRAP
Cut 2
(optional)

12

2A

1A

2B

1A

1B

GRAINLINE



2C

1B

1C



2D

1D

G
bric
racing

FOLD

XXX

XL

L

M

S

1C

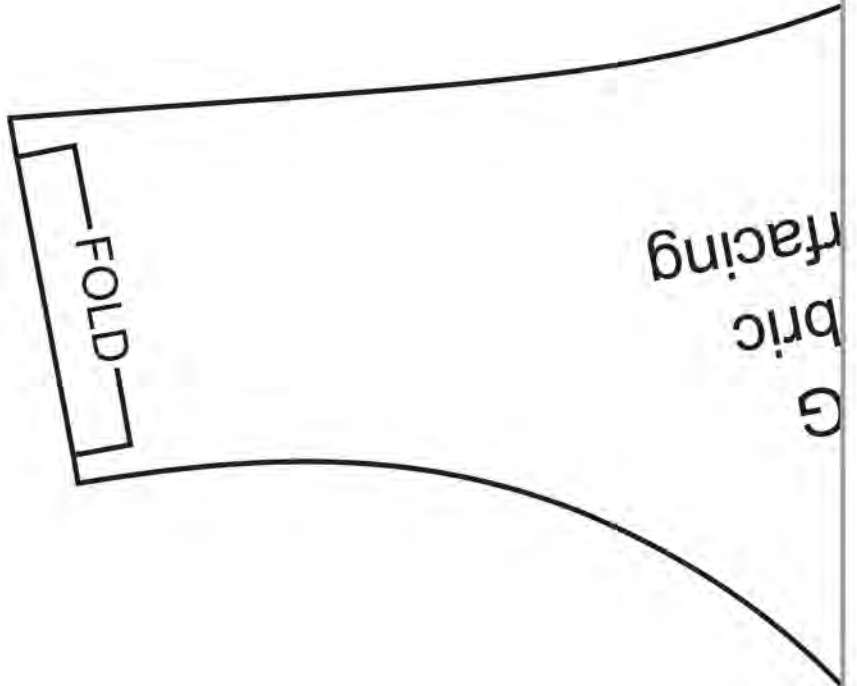
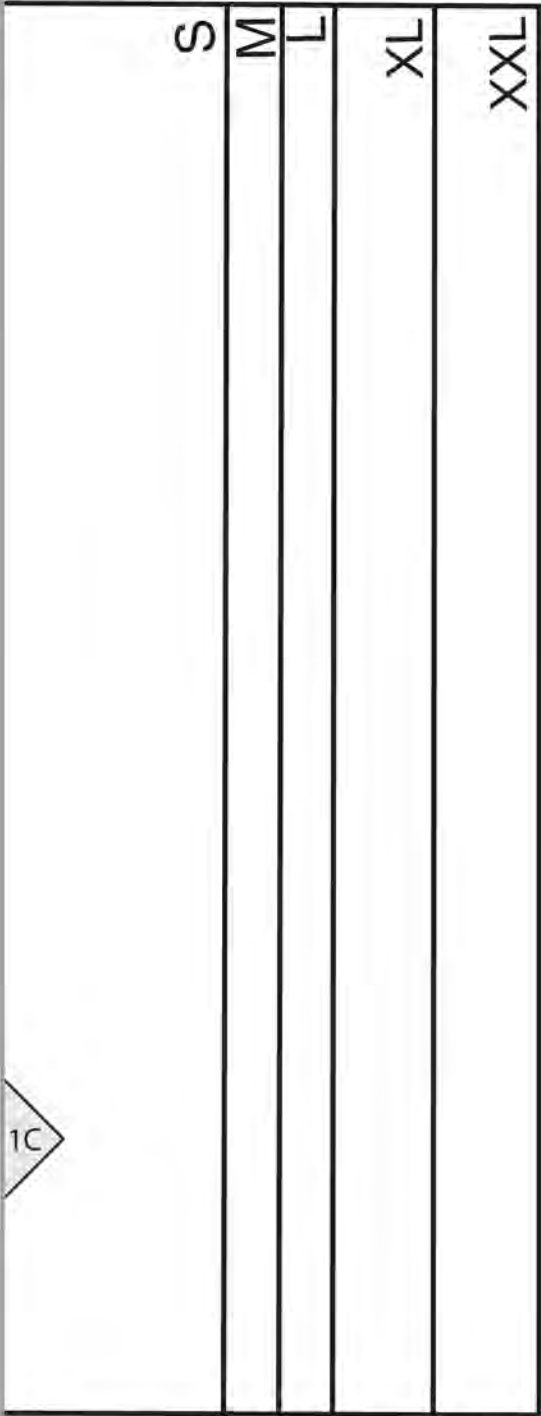

2E

1D

10

A4 FRONT FACIN
Size XXL
Cut 1 on FOLD of fa
Cut 1 on FOLD of inte

TANK (A)

XXL

